

VEICHI

AC10 General-Purpose VFD



VEICHI

Suzhou Veichi Electric Co., Ltd

No.1000 Songjia Road, Guoxiang street, Wuzhong Economic and Technological Development Zone, Suzhou
Tel:+86-512-6617 1988
Fax:+86-512-6617 3610

Facebook: <https://www.facebook.com/veichigroup>
Whatsapp: +86-138 2881 8903
<https://www.veichi.org/>



Official Website

*Version:2022 V1.1
Veichi Electric Co., Ltd all rights reserved,
subject to change without notice.

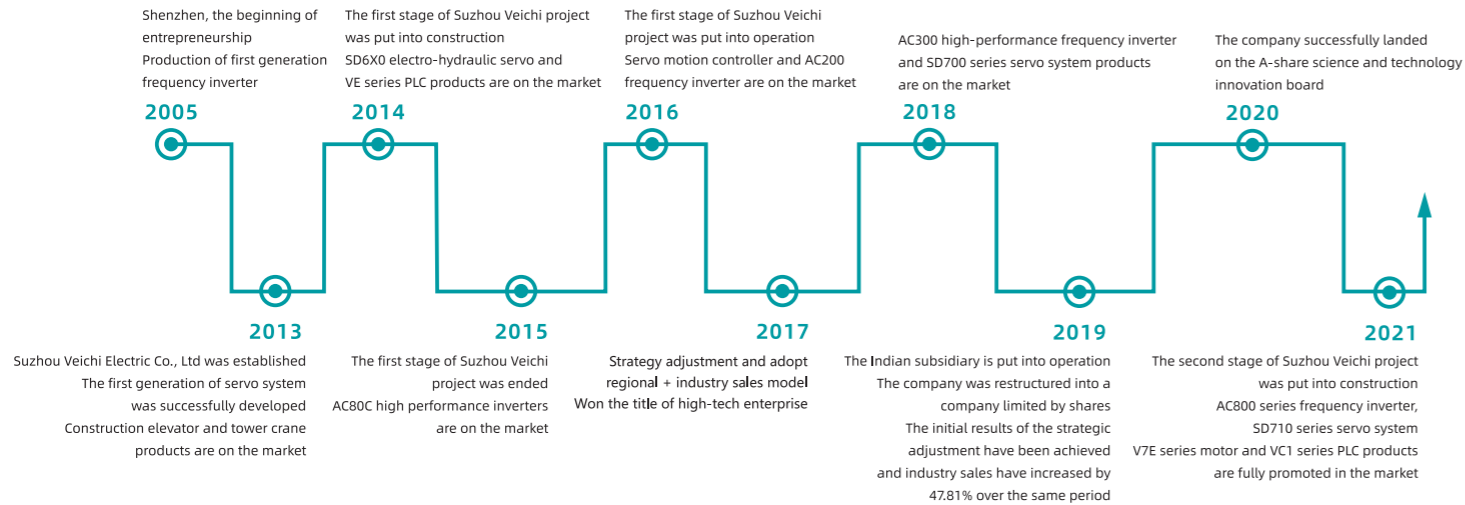

VEICHI Electric, a high-tech enterprise engaged in the R&D, production and sales of industrial automation products, has always focused on the fields of electric drive and industrial control since its establishment. It has been listed as the "Jiangsu Provincial Enterprise Technology Center", "Jiangsu Private Technology Enterprise", "Jiangsu Provincial Specialized and New Giant Enterprise", "Jiangsu Provincial Engineering Technology Research Center", "Suzhou Gazelle Enterprise" and "Competitive Brand in Motion Control Field". After years of independent R&D and innovation, VEICHI has developed a series of independent intellectual property rights. By the end of December 28, 2021, a total of 124 patents have been granted, including 28 invention patents.

VEICHI has R&D and production bases in Suzhou and Shenzhen, and has established a wholly-owned subsidiary in India. At present, the company's business covers many countries and regions, providing global customers with competitive, safe and reliable products and services.

We supply a wide range of products, including inverters from 0.4kW to 1,200kW, servo systems from 50W to 200kW, motion controllers, PLCs and HMIs, to diverse customers in lifting and mining equipment, rail transportation, machine tools, compressors, plastics, solar water pumping, building materials, robots or manipulators, printing and packaging, textile and chemical fiber, metallurgy, municipal, petroleum, chemical and other industries.

VEICHI has established 19 service outlets in China, and developed 139 channel dealers, covering 31 provinces and Hong Kong, Macao and Taiwan regions across the country, forming a wide-ranging and efficient distribution and service network to provide customers with high-quality products and efficient Service.

VEICHI will continue to adhere to the business philosophy of "Guided by market demand, Driven by technological innovation", to expand and strengthen the core businesses of inverters, servo systems and motion controllers, and intelligent IoT, and always insist on providing customers with best products and services. VEICHI will spare no effort to make contributions to promote the development of electric drive and industrial control.

AC10 General Purpose

AC10 series frequency inverter is a product developed on the latest technology platform of VEICHI. AC10 products are based on the users market demand for miniaturization, high reliability and high cost performance. As a narrow-body VFD, AC10 has convenient way of installation, small size, low temperature rise, high protection, strong software performance and many other advantages. The development of AC10 relies on the advanced PLM R&D management system to ensure that the hardware, software structure and test process are stereoscopic, systematic and traceable, which ensures the preciseness and scientificity of the product in every detail.

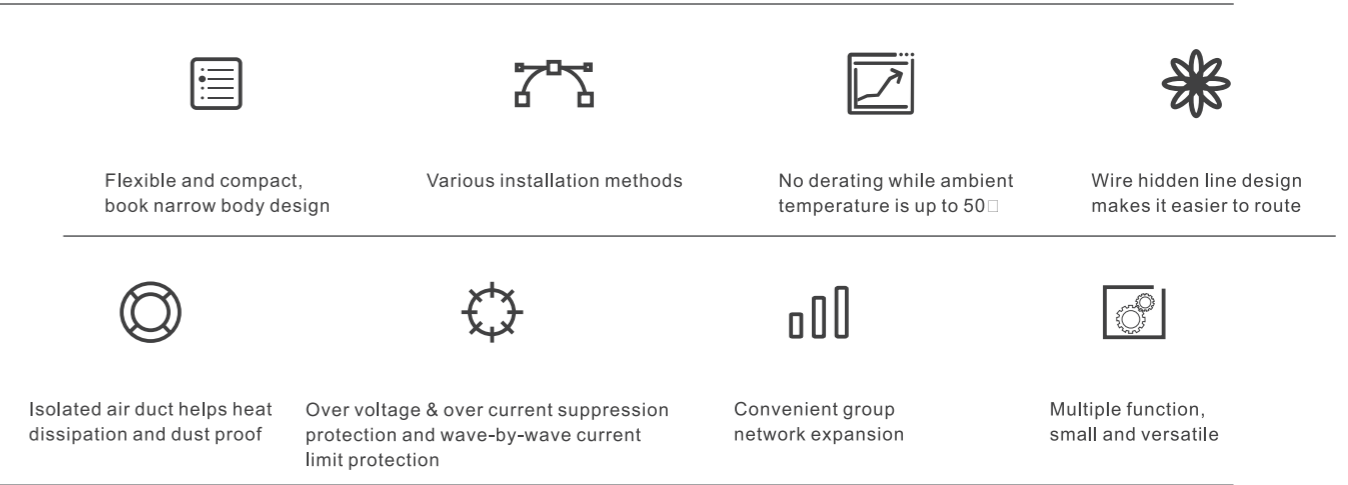
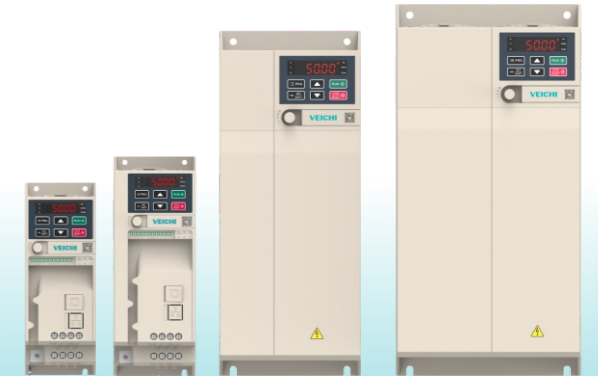

Structural Features

0.4kW-5.5kW interface

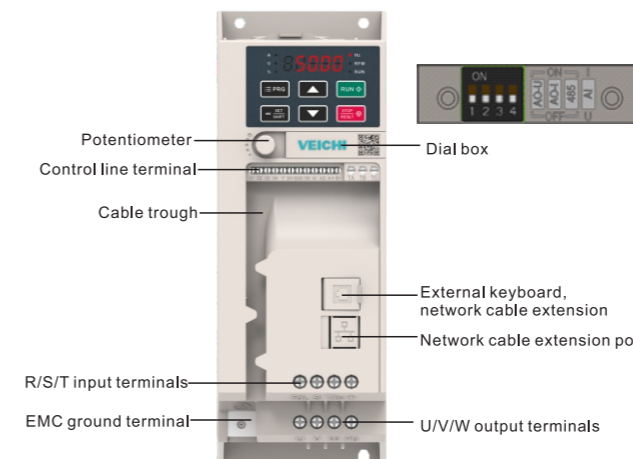

7.5kW-22kW power band interface introduction

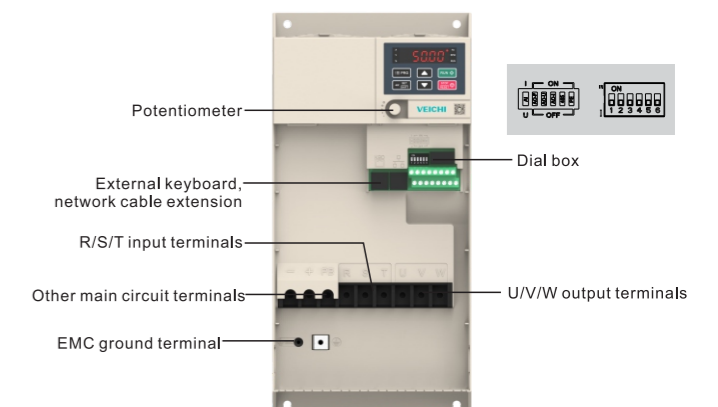

Installation Methods

Support penetration installation (wall installation, embedded installation); Adapt to various installation environments

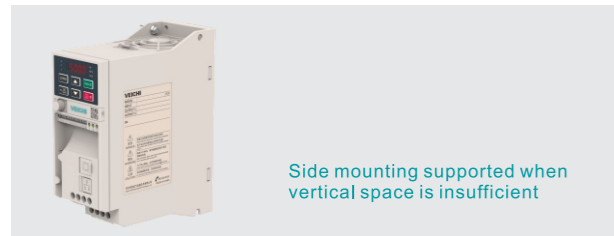

Protective Design

High protection: completely independent air duct, scientific layout inside the machine, help the heat dissipation of high-power devices and the dust-proof of the sensing device

High temperature resistance: scientific air duct design, which can quickly dissipate heat, low temperature rise of the machine, and no need of derating at an ambient temperature of 50 °C.

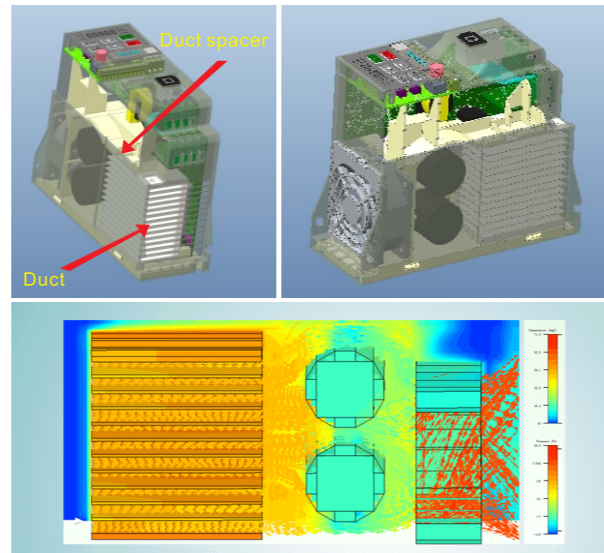

Control terminal wiring specifications

Rational parameters	Strip length (mm)	Wire gauge (AWG)	Screw
Specification	4-5	30-14	M2

Main circuit terminal wiring specifications

Power range: 0.4kW ~ 5.5kW

	AC10 power level	Wire diameter (mm)	Wire cross-sectional area (mm²)	Strip length (mm)
Main circuit terminal	0.4kW-2.2kW	0.25-2.5	0.05-5.2	7-8
	4kW-5.5kW	0.5-2.5	0.2-5.2	6-8

Wire stripping diagram

Power range: 7.5kW~22kW

Model	Main circuit terminal screw specifications (mm)	Recommended fixed torque (N·m)	Recommended copper core cable specifications mm² (AWG)
AC10-T3-7R5G-B	M4	1.2~1.5	6mm²(9)
AC10-T3-011G-B	M4	1.2~1.5	10mm²(7)
AC10-T3-015G-B	M5	2~3	10mm²(7)
AC10-T3-018G-B	M5	2~3	16mm²(5)
AC10-T3-022G-B	M5	2~3	16mm²(5)

Keyboard operation

Keypad operation continues with the AC300/AC310 for quick entry. The external expansion keyboard can be used with the AC300/AC310. Three keyboard styles are supported (all-in-one, single external, and dual external)

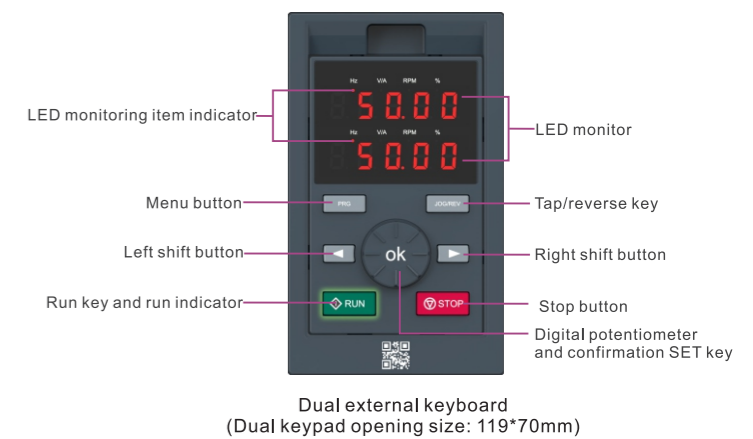

Wiring Terminals

The terminal layout of AC10 VFD is simple and beautiful, with more technological aesthetics.

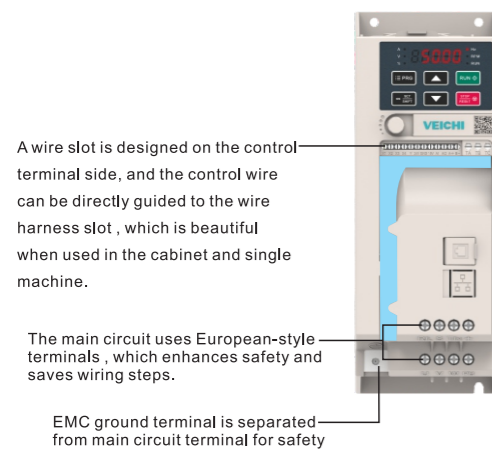

Network Port Extension Interface

The network model supports RS485 (standard), which could be directly extended through the network port. Customers only need to make a network cable connection, convenient and beautiful.

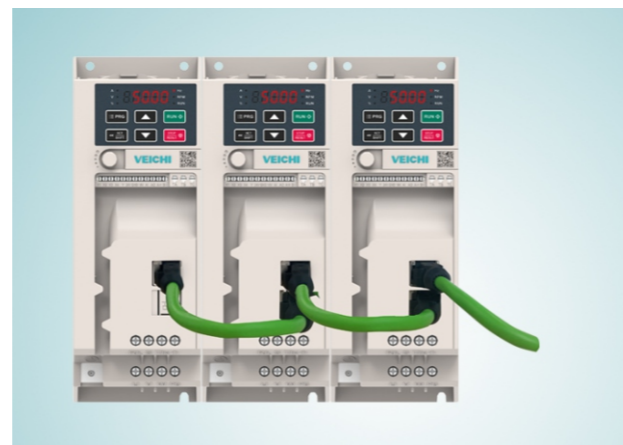

Performance Characteristics

Over-voltage Suppression

When the bus voltage reaches or exceeds the bus overvoltage suppression point during the running of the frequency inverter, it will automatically adjust the operating frequency to suppress the bus voltage rise, thus ensuring that the frequency inverter does not cause over-voltage protection

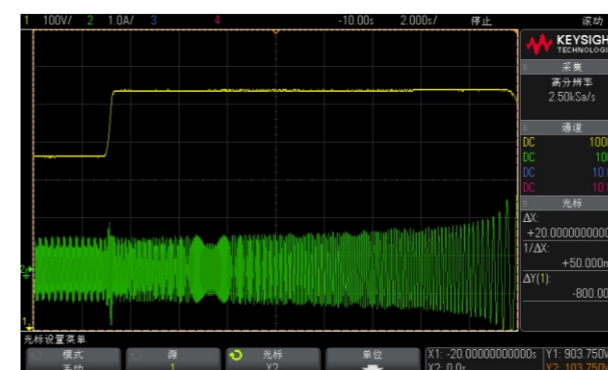

Under-voltage suppression

Under-voltage Suppression When the frequency inverter suddenly loses power during operation, the frequency inverter will automatically adjust the operating frequency after the bus voltage drops to the under-voltage suppression point, thus ensuring that the frequency inverter will not report under-voltage faults due to the low bus voltage in a short time. When the power supply is restored within the valid period of under-voltage suppression, the frequency inverter can continue to operate normally

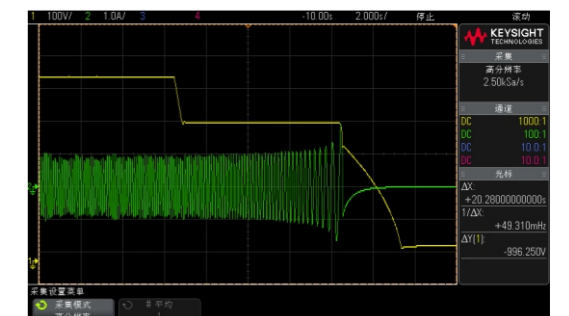

Comprehensive Fault Protection

The AC10 fault protection is more comprehensive and detailed, and it can find the problem more quickly and accurately in the event of an error.

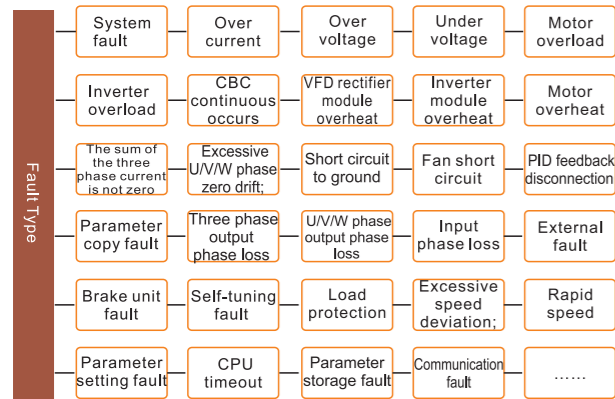

Over-current suppression

The overcurrent suppression function is to real-time monitor and automatically limit the load current during operation, so that it does not exceed the overcurrent suppression point, thus to prevent the fault trip caused by excessive current.

This function is especially used for some loads with large inertia or severe changes. The setting is only valid under V/F control, and the overcurrent suppression function under the vector control is always valid.



Virtual Oscilloscope

The AC10 has virtual oscilloscope software that can monitor four parameters at the same time. Users can monitor the operating parameters in real time on the computer through the virtual oscilloscope, which makes monitoring, debugging and troubleshooting more flexible.

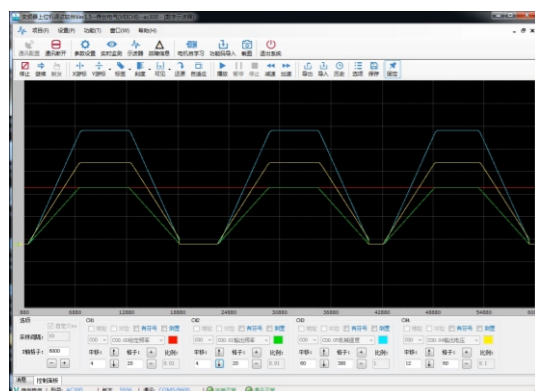

Excellent Control Performance

The AC 10 is a high-performance frequency inverter that supports PG-free vector control in addition to the universal V/F control mode. It has excellent control performance and can adapt to more complex operating conditions.

Main control performance	Motor type	Asynchronous motors, synchronous motors (only T3 machines can drive synchronous motors)
	Motor control method	No PG V/F control, no PG vector control (only T3 machines support vector control)
	Modulation method	Optimized space vector PWM modulation
	Speed control range	No PG vector control, rated load 1:100
	Steady-state speed accuracy	No PG vector control: ≤2% Rated synchronous speed
	Starting torque	No PG vector control : 150% rated torque at 0.5Hz
	Torque Response	No PG vector control : < 20ms
	Frequency accuracy	Digital setting: Max. frequency±0.1%; Analog setting: Max. frequency±0.2%
	Frequency resolution	Digital setting 0.01Hz; Analog setting: Max.frequency×0.05%

Wave-by-Wave Current Limit

The wave-by-wave current limit could limit the rise of current to a certain extent through the hardware protection, so that the current does not exceed the protection value of the frequency inverter, to avoid the inverter stop due to over current fault.



Firmware filed upgrade

VEICHI firmware upgrade software provides great convenience for the filter upgrade of AC10 firmware.

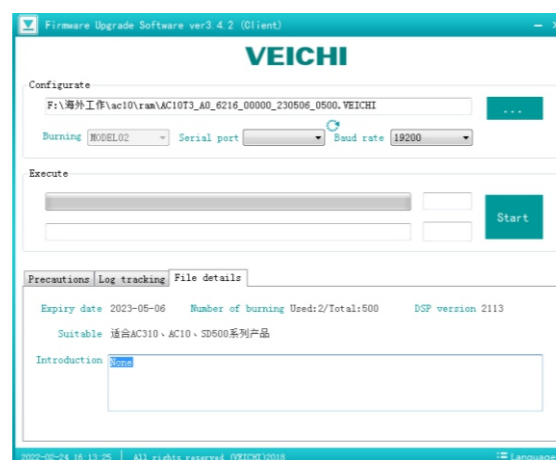

Model Description

AC10 model naming rules

AC10-T 3-1R5 G-B



① Machine Series AC10 Series	④ Adaptable motor power R75:0.75kW 1R5:1.5kW 2R2:2.2kW 004:4kW
② Voltage Type T:Three-phase S:Single-phase	⑤ Load type G Heavy duty type
③ Voltage Rating 2:220V 3:380V	⑥ Accessory type B: Brake unit

Rated output current

Voltage	Rated output current(A)	
	220V	380V
Power (KW)		
0.4	2.5	—
0.75	4	3
1.5	7	4
2.2	10	5
4	—	9.5
5.5	—	13
7.5	—	17
11	—	25
15	—	32
18.5	—	38
22	—	45

Installation Size

0.4kW-5.5kW Installation Size Chart

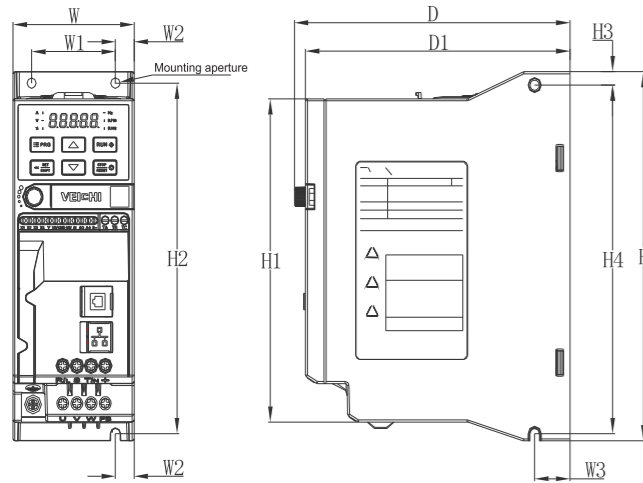

Inverter model	Dimension(mm)					Mounting dimensions (mm)						Mounting aperture
	W	H	H1	D	D1	W1	W2	H2	W3	H3	H4	
AC10-T/S2-R04G-B	65	177	155	148	142	45	10	168	19	6.5	167	3-M4
AC10-T/S2-R75G-B												
AC10-T/S2-1R5G-B	75	202	180	163	157	55	10	193	19	6.5	192	3-M4
AC10-T/S2-2R2G-B												
AC10-T3-R75G-B	65	177	155	148	142	45	10	168	19	6.5	167	3-M4
AC10-T3-1R5G-B												
AC10-T3-2R2G-B												
AC10-T3-004G-B	75	202	180	163	157	55	10	193	19	6.5	192	3-M4
AC10-T3-5R5G-B												

7.5kW-22kW Installation Size Chart

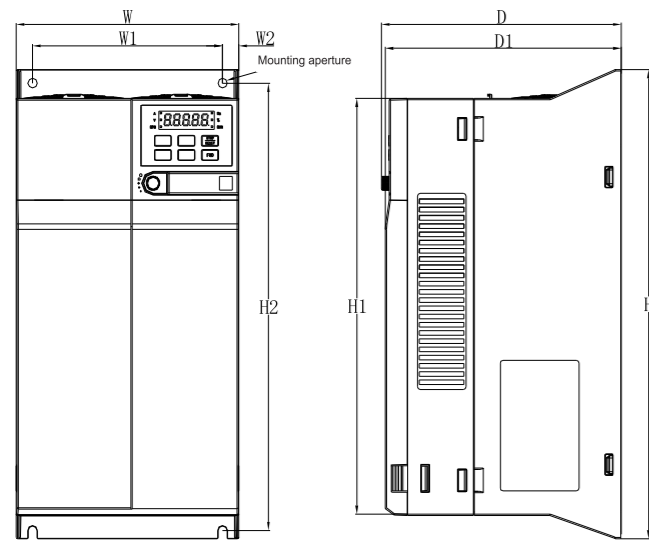

Inverter model	Dimension(mm)					Mounting dimensions (mm)						Mounting aperture
	W	H	H1	D	D1	W1	W2	H2	W3	H3	H4	
AC10-T3-7R5G-B	130	320	286	161	158	105	12.5	302	-	-	-	M5
AC10-T3-011G-B												
AC10-T3-015G-B												
AC10-T3-018G-B	170	342.5	303.5	183	180	145	12.5	326.5	-	-	-	M5
AC10-T3-022G-B												

Control terminal parameters

	Type	Terminal Symbols	Maximum input/output capacity
Control line terminals	Power terminals	+10V-GND	DC10V, 50mA
		0.4kW-5.5kW power band 7.5kW-22kW power band	DC24V, 100mA
	Analog input	AI-GND	1. DC0V~10V 2. 0mA ~ 20mA
	Digital input	X1~X4-GND (0.4kW-5.5kW power range) X1~X4-COM (7.5kW-22kW power range)	1.High level: 10~30V 2.Low Level: 0~5V 3.X4 (PUL) : 100KHz
	Analog output	AO-GND	1.DC 0V~10V 2.DC 0mA~20mA
	Digital output	Y - GND (0.75kW-5.5kW) Y - COM (7.5kW-22kW)	Open collector output 1.DC 0V~30V 2.DC 0mA~50mA
	Relay normally open terminals	TA-TC	Contact drive capability 1.240VAC , 3A 2.30VDC , 5A
	Relay normally closed terminal	TB-TC	
	RS485 communication terminal	A+	RS485 communication interface Select by dipswitch whether to connect terminal resistor
B-			

Terminal wiring diagram

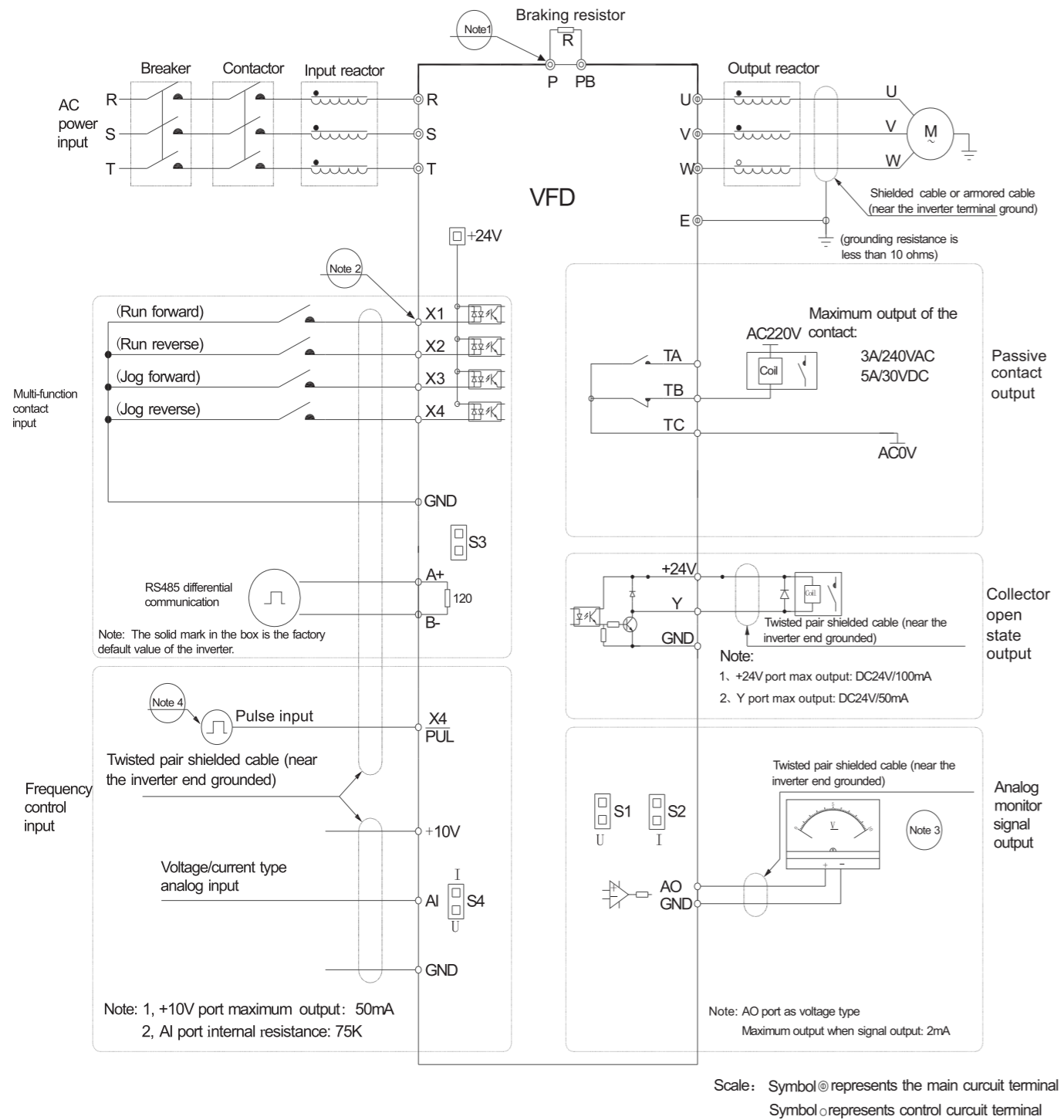

Applications

