

Operation Manual of PROFINET 300 Series

Expansion Card

1 Product Overview

Thank you for using VEICHI AC300 series frequency inverter (AC300 and AC310 frequency inverter) and choosing AC300 PROFINET expansion card AC300PN1. The AC300PN1 card is composed of two boards, which are connected by communication line. The physical diagram of the two boards is shown in Figure 1.1



Figure 1.1 Hardware object diagram

2 Hardware layout and RJ45 interface

2.1 Hardware Layout

The hardware layout of AC300PN1 card is shown in Figure 2.1

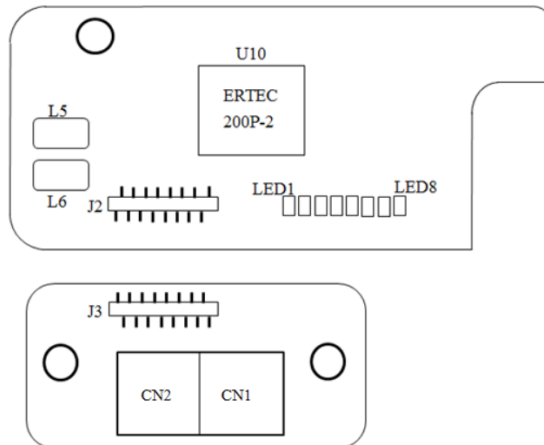

Figure 2.1 Hardware layout

The communication status of AC300PN1 card can be displayed by indicator light. The meaning of different status of each indicator is shown in Table 2.1

Table 2.1 description of indicator light

Indicator light	Indicator status	State description	Processing method
Power	Light on	The power supply is normal	Nothing
	Light off	Abnormal power supply	Power on or replace the expansion card
Led1	Light on	RJ45 port is not started, and the power system is faulty	Check whether the network cable is connected correctly, and check whether the GSD version

			or configuration is wrong
	Light off	RJ45 port is started, and the power system is normal	Nothing
Led2	Flashing	Inverter fault	Check the frequency inverter fault type, and then do further processing
	Light off	The frequency inverter is normal	Nothing
Led3	Flashing	Abnormal communication check between expansion card and frequency inverter	Check the version of frequency inverter PN card and software; Observe whether the card is inserted into the frequency inverter; replace the expansion card
	Light off	Normal	Nothing
Led4	Flashing	The function of the expansion card to read and write the inverter is abnormal	Confirm whether the GSD file is correct; Check whether the selected address of PZD is correct
	Light off	Normal	Nothing
Led5	Flashing (0.25s)	Abnormal connection of master station	Check the wiring of the master station
	Flashing (0.5s)	Abnormal connection of master station	The master station is connected to the slave station or is downloading PLC program
	Light off	Master slave communication is normal	Nothing
Link0/1	The green light is on	The power supply of network cable is normal	Nothing
	The green light is off	The power supply of network cable is abnormal	Check whether the communication line is plugged in properly
	The yellow light is on	Communication is normal	Nothing
	The yellow light is flashing	Establishing communication	Nothing

2.2 PROFINET RJ45 interface description

AC300PN1 is connected with PROFINET master station by standard Ethernet RJ45 socket. Its pin definition is consistent with that of standard Ethernet pin, both cross line and direct connection are available

Table 2.2 PROFINET communication terminal description

Terminal name	Explain
Network port CN1	The terminal has no direction and can be connected to the terminal near PLC. Facing RJ45, the right side is network port 1, and the left side is network port 2.
CN2 port network	

3 Communication Configuration Description

AC300PN1 card supports AC300 series frequency inverters (AC300 and AC310 frequency inverters). The relevant function codes should be set for the AC 300PN1 card to communicate with the frequency inverter normally

3.1 AC300 Communication Configuration

3.1.1 Description of AC300 Inverter Communication Configuration

Table 3.1.1 AC300 function code setting

Function code	Name	Setting range	Setting value	Meaning
F00.02	Run command selection	0: Keyboard given 1: Terminal setting 2: RS485 3: Purchase card	2	The command is given by RS485
F00.03	Frequency given source channel	0: keyboard number given 1: Keyboard analog potentiometer setting ... 10: Purchase card	6	The frequency is given by RS485
F00.10	Upper limit frequency source selection	Select the given source of frequency inverter upper limit 0: Upper limit frequency given 1: Reserved 2: Current and voltage analog AI1 given 3: Current and voltage analog AI2 given 4: Reserved 5: Terminal pulse PUL setting 6: RS485 communication given 7: Purchase card	-	If you use AC300PN1 card to limit the upper limit frequency, you need to set this to 6
F07.01	Torque command setting	0: Keyboard number 1: Keyboard potentiometer setting ... 6: RS485 communication setting 7: Purchase card	-	If the torque command is given by AC300PN1 card, it is set to 6
F07.10	Speed limit	0: Set by function code	-	If restricted by AC300PN1 card, it

	selection of forward rotation in torque control	F07.12 1: Reservation ... 6: RS485 given * F07.12 7: Purchase card * F12.07		is set to 6
F07.11	Torque control reverse speed limit selection	0: Set by function code F07.13 1: Reservation ... 6: RS485 given * F07.13 7: Purchase card * F07.13	-	If restricted by AC300PN1 card, it is set to 6
F07.12	Maximum forward speed when controlled by torque	0.0%~100.0%	-	Default 100.0%, relative maximum frequency (F00.09)
F07.13	Maximum reverse speed when controlled by torque	0.0%~100.0%	-	Default 100.0%, relative maximum frequency (F00.09)

3.1.2 Address Description of AC300 Communication Control Group

Table 3.1.2 Address description of AC300 communication control group

Address definition	Function description	Explanation of data significance	R/W characteristic
0x3000	Communication given frequency	0.01 Hz, e.g.: 5000 corresponds to 50Hz	R/W
0x3001	Communication command setting	0: No command 1: Forward running 2: Reverse running 3: Forward jog 4: Reverse jog 5: Slow down and stop 6: Freely stop 7: Fault reset 8: Run forbidden command 9: Run allow command	R/W
0x3004	Communication given upper limit frequency	Unit: 0.01Hz	R/W
0x3005	Communication torque setting	Unit 0.1%	R/W
0x3006	Maximum forward frequency limit of torque control	Unit 0.1%	R/W
0x3007	Maximum reverse frequency limit of torque control	Unit 0.1%	R/W
0x3008	Communication given PID setting value	Unit 0.1%	R/W

0x3009	Communication given PID feedback value	Unit 0.1%	R/W
0x300A	Voltage setting of voltage frequency separation	Unit 0.1%	R/W
0x300B	Tension setting	0 ~ maximum tension	R/W
0x300C	Coil diameter setting	0 ~ maximum coil diameter	R/W
0x300D	Linear speed setting	0 ~ maximum linear speed	R/W
0x300E	retain	-	R/W
0x300F	retain	-	R/W
0x3011	retain	-	R/W
0x3012	retain	-	R/W
0x3013	retain	-	R/W
0x3014	retain	-	R/W
0x3015	retain	-	R/W

3.1.3 AC300 Communication Monitoring Function Code or Address

Table 3.1.3 AC300 communication monitoring table

Parameter code (address)	Name	Explain	R/W	
0x3002	Inverter status	Bit0	0: Shutdown state, 1: Running state	R
		Bit1	0: Non acceleration state, 1: Acceleration state	
		Bit2	0: Non deceleration state, 1: Deceleration state	
		Bit3	0: Forward, 1: Reverse	
		Bit4	0: No fault, 1: Inverter fault	
		Bit5	0: GPRS non lock, 1: GPRS lock	
		Bit6	0: No warning, 1: Inverter warning	
		Bit7	0: No-ready, 1: Ready	
		Bit8	0: No fault in communication with control board 1: Communication failure with control board	
0x3010	Retain	-	R	
0x3018	Retain	-	R	
0x3019	Retain	-	R	
0x301A	Retain	-	R	
C00.00(0x2100)	Given frequency	0.01Hz	R	

C00.01(0x2101)	Output frequency	0.01Hz	R
C00.02(0x2102)	Output current	0.1A	R
C00.03(0x2103)	Input voltage	0.1V	R
C00.04(0x2104)	Output voltage	0.1V	R
C00.05(0x2105)	Mechanical speed	1rpm	R
C00.06(0x2106)	Given torque	0.1%	R
C00.07(0x2107)	Output torque	0.1%	R
C00.08(0x2108)	PID given	0.1%	R
C00.09(0x2109)	PID feedback	0.1%	R
C00.10(0x210A)	Output power	0.1%	R
C00.11(0x210B)	Bus voltage	0.1V	R
C00.12(0x210C)	Module temperature 1	0.1°C	R
C00.13(0x210D)	Module temperature 2	0.1°C	R
C00.14(0x210E)	On state of input terminal X	-	R
C00.15(0x210F)	On state of output terminal Y	-	R
C00.16(0x2110)	AI1 analog input value	0.001V/0.001mA	R
C00.17(0x2111)	AI2 analog input value	0.001V/0.001mA	R
C00.18(0x2112)	Retain	-	R
C00.19(0x2113)	Pulse signal PUL input value	0.001kHz	R
C00.20(0x2114)	Analog output AO1	0.01V/0.01mA/0.01kHz	R
C00.21(0x2115)	Analog output AO2	0.01V/0.01mA/0.01kHz	R
C00.22(0x2116)	Counter count value	1	R
C00.23(0x2117)	Operation time of this power on	0.1 hours	R
C00.24(0x2118)	Accumulated operation time of the machine	Hour	R
C00.25(0x2119)	Power level of frequency inverter	0.1kW	R
C00.26(0x211A)	Rated voltage of frequency inverter	V	R
C00.27(0x211B)	Rated current of frequency inverter	0.1A	R
C00.28(0x211C)	Software version	-	R
C00.29(0x211D)	PG feedback frequency	0.01Hz	R
C00.30(0x211E)	Timer timing time	Second, minute, hour	R
C00.31(0x211F)	PID output value	0.01%	R
C00.32(0x2120)	Sub version of inverter software	-	R
C00.33(0x2121)	Encoder feedback angle	0.1°	R
C00.34(0x2122)	Accumulated error of Z pulse	1	R
C00.35(0x2123)	Z pulse count	1	R
C00.36(0x2124)	Warning code fault	0 ~ 63 fault number, 64 ~ 128 warning number	R

C00.37(0x2125)	Accumulated power consumption (low level)	1KWh	R
C00.38(0x2126)	Accumulated power consumption (high level)	10000 KWh	R
C00.39(0x2127)	Power factor angle	0.1°	R

3.2 AC310 Communication Configuration

3.2.1 Description of AC310 Communication Configuration

Table 3.2.1 AC310 function code setting

Function code	Name	Setting range	Setting value	Meaning
F01.01	Operation command selection	0: Keyboard given 1: Terminal setting 2: RS485 3: Purchase card given 4: Terminal switching command given	3	The running command is given by AC300PN1 card
F01.02	Frequency given source channel	0: Keyboard number given 1: Keyboard analog potentiometer setting ... 10: Purchase card	10	Frequency command is given by AC300PN1 card
F01.11	Upper limit frequency source selection	Select the given source of frequency inverter upper limit 0: Upper limit frequency given 1: Reservation 2: Voltage analog VS given 3: Current or voltage analog AI given 4: Current analog AS given 5: Terminal pulse PUL given 6: RS485 communication given 7: Purchase card	-	If you use AC300PN1 card to limit the upper limit frequency, you need to set this to 7
F03.41	Torque command setting	0: Keyboard number 1: Keyboard potentiometer setting ... 7: Purchase card	-	If the torque command is to be given by AC300PN1 card, it is set to 7
F03.54	Speed limit selection of forward rotation in torque control	0: Set by function code F03.56 1: Reservation ... 7: Purchase card * F03.56	-	If you need to limit the speed through the AC300PN1 card, you need to set this to 7
F03.55	Speed limit	0: Set by function code F03.57	-	If you need to limit the

	selection of reverse rotation in torque control	1: Reservation ... 7: Purchase card * F03.57		speed through the AC300PN1 card, you need to set this to 7
F03.56	Maximum forward speed when controlled by torque	0.0%~100.0%	-	Relative maximum output frequency (F01.10)
F03.57	Maximum reverse speed when controlled by torque	0.0%~100.0%	-	Relative maximum output frequency (F01.10)
F12.32	Treatment of disconnection between PN card and inverter	0: No detection 1: Alarm and freely stop 2: Warn and continuously run		Treatment method of AC300PN1 card after detection of disconnection with control board (Ebus4/A. buS)
F12.43	Master slave communication failure action	0: No detection 1: Alarm and freely stop 2: Warn and continuously run	-	Handling mode in case of master-slave communication failure (when PLC is disconnected from equipment or PLC is in stop state, Ebus3/A. buS is reported)
F12.50	Processing method of communication disconnection of expansion card (frequency inverter processing)	Ones place: EX-A breaking treatment Tens place: EX-B breaking treatment 0: No detection 1: Alarm and freely stop 2: Warn and continuously run	-	Processing mode selection in case of communication failure between AC300PN1 card and frequency inverter,. (frequency inverter self detection, reporting Ebus1/A. buS)

3.2.2 Address Description of AC310 Communication Control Group

Table 3.2.2 Address description of AC310 communication control group

Address definition	Function description	Explanation of data significance	R/W characteristic
0x3100	Communication given frequency	0.01 Hz, e.g.: 5000 corresponds to 50Hz	R/W
0x3101	Communication command setting	0: No command	R/W

		1: Forward running 2: Reverse running 3: Forward jog 4: Reverse jog 5: Slow down and stop 6: Freely stop 7: Fault reset 8: Run forbidden command 9: Run allow command	
0x3104	Communication given upper limit frequency	Unit: 0.01Hz	R/W
0x3105	Communication torque setting	Unit 0.1%	R/W
0x3106	Maximum forward frequency limit of torque control	Unit 0.1%	R/W
0x3107	Maximum reverse frequency limit of torque control	Unit 0.1%	R/W
0x3108	Communication given PID setting value	Unit 0.1%	R/W
0x3109	Communication given PID feedback value	Unit 0.1%	R/W
0x310A	voltage setting of voltage frequency separation	Unit 0.1%	R/W
0x310B	Tension setting	0 ~ maximum tension	R/W
0x310C	Coil diameter setting	0 ~ maximum coil diameter	R/W
0x310D	Linear speed setting	0 ~ maximum linear speed	R/W
0x310E	Acceleration time 1	Set unit by function code F01.21	R/W
0x310F	Deceleration time 1	Set unit by function code F01.21	R/W
0x3111	Torque current component	0 ~ 4000 (corresponding to 0.0% ~ 400.0%)	R/W
0x3112	Torque filtering time	0 ~ 6000 (corresponding to 0.000s-6.000s)	R/W
0x3113	Tension PID feedback	0 ~ 1000 (corresponding to 0.0% ~ 100.0%)	R/W
0x3114	Communication given torque limit in jog state	0 ~ 4000 (corresponding to 0.0% ~ 400.0%)	R/W
0x3115	Communication given torque limit in generation state	0 ~ 4000 (corresponding to 0.0% ~ 400.0%)	R/W

3.2.3 AC310 Communication Monitoring Function Code Or Address

Table 3.2.3 AC310 communication monitoring table

Parameter code (address)	Name	Explain		R/W
0x3102	Inverter status	Bit0	0: Shutdown state, 1: Running	R

			state	
		Bit1	0: Non accelerated topic, 1: Accelerated state	
		Bit2	0: Non deceleration state, 1: Deceleration state	
		Bit3	0: Forward, 1: Reverse	
		Bit4	0: No fault, 1: Fault	
		Bit5	0: GPRS non lock, 1: GPRS lock	
		Bit6	0: No warning, 1: Warning	
		Bit7	0: No-ready, 1: Ready	
		Bit8	0: No fault in communication with control board 1: Communication failure with control board	
0x3110	Retain	-		R
0x3118	Retain	-		R
0x3119	Retain	-		R
0x311A	Retain	-		R
C00.00(0x2100)	Given frequency	0.01Hz		R
C00.01(0x2101)	Output frequency	0.01Hz		R
C00.02(0x2102)	Output current	0.1A		R
C00.03(0x2103)	Input voltage	0.1V		R
C00.04(0x2104)	Output voltage	0.1V		R
C00.05(0x2105)	Mechanical speed	1rpm		R
C00.06(0x2106)	Given torque	0.1%		R
C00.07(0x2107)	Output torque	0.1%		R
C00.08(0x2108)	PID given	0.1%		R
C00.09(0x2109)	PID feedback	0.1%		R
C00.10(0x210A)	Output power	0.1%		R
C00.11(0x210B)	Bus voltage	0.1V		R
C00.12(0x210C)	Module temperature 1	0.1°C		R
C00.13(0x210D)	Module temperature 2	0.1°C		R
C00.14(0x210E)	Input terminal X On state	-		R
C00.15(0x210F)	Output terminal X on state	-		R
C00.16(0x2110)	AI1 analog input value	0.001V/0.001mA		R
C00.17(0x2111)	AI2 analog input value	0.001V/0.001mA		R
C00.18(0x2112)	Retain	-		R
C00.19(0x2113)	Pulse signal PUL input value	0.001kHz		R
C00.20(0x2114)	Analog output AO1	0.01V/0.01mA/0.01kHz		R
C00.21(0x2115)	Analog output AO2	0.01V/0.01mA/0.01kHz		R
C00.22(0x2116)	Counter count value	1		R
C00.23(0x2117)	Operation time of this power on	0.1 hour		R

C00.24(0x2118)	Accumulated operation time of the machine	hour	R
C00.25(0x2119)	Power level of frequency inverter	0.1kW	R
C00.26(0x211A)	Rated voltage of frequency inverter	V	R
C00.27(0x211B)	Rated current of frequency inverter	0.1A	R
C00.28(0x211C)	Software version	-	R
C00.29(0x211D)	PG feedback frequency	0.01Hz	R
C00.30(0x211E)	Timer timing time	Second, minute, hour	R
C00.31(0x211F)	PID output value	0.01%	R
C00.32(0x2120)	Sub version of inverter software	-	R
C00.33(0x2121)	Encoder feedback angle	0.1°	R
C00.34(0x2122)	Accumulated error of Z pulse	1	R
C00.35(0x2123)	Z pulse count	1	R
C00.36(0x2124)	Warning code fault	0 ~ 63 fault number, 64 ~ 128 warning number	R
C00.37(0x2125)	Accumulated power consumption (low level)	1 KWh	R
C00.38(0x2126)	Accumulated power consumption (high level)	10000 KWh	R
C00.39(0x2127)	Power factor angle	0.1°	R

3.3 Description of Communication Configuration between AC300PN1 Card and PROFINET Master Station

After the communication between the main station and the main station is set up correctly, the communication between the main station and the main station can be realized by setting the communication card with the main station. Taking AC310 as an example, after the communication between AC300PN1 card and AC310 inverter is realized, it is necessary to connect with PROFINET master station correctly. After setting relevant configuration, the communication between AC300PN1 card and master station can be realized.

3.3.1 PROFINET Wiring Diagram

PROFINET supports a variety of connection modes. Through reasonable use of switches, different networking modes can be realized, as shown in the figure below

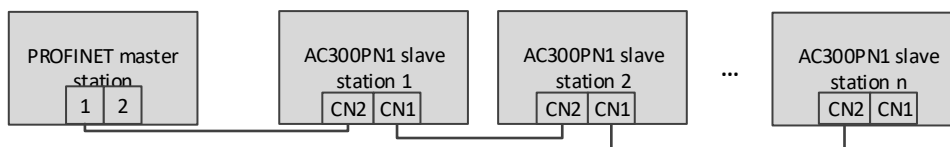

Figure 3.1 Schematic diagram of string connection

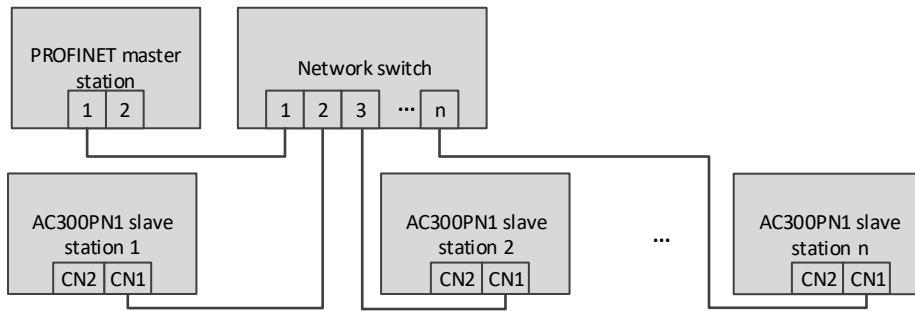

Figure 3.2 Schematic diagram of star connection

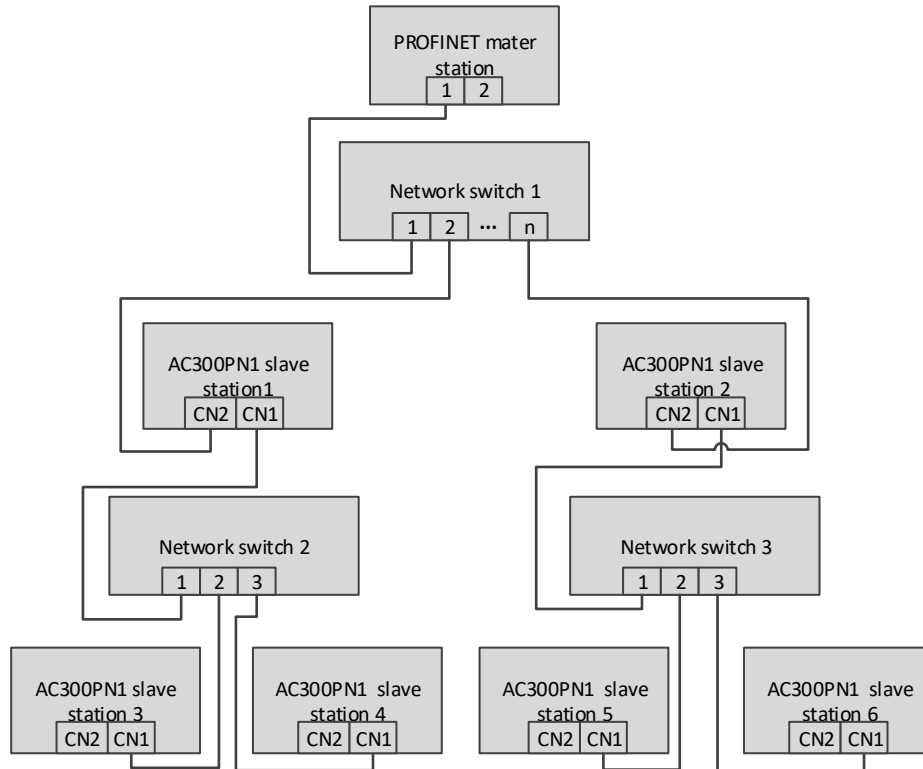

Figure 3.3. Schematic diagram of connection tree

3.3.2 communication description

AC300PN1 card requires customers to select different PZD lengths for transmission according to different requirements. Users can select the corresponding functions of each PZD in the configuration. The functions supported by each data format are shown in the table below

Table 3.3 data format description

Data type	Data length	Supported features
Standard telegram 1	PZD-2/2	Frequency inverter command and frequency setting Operation status and frequency feedback of frequency inverter
Standard telegram 2	PZD-4/4	Frequency inverter command and frequency setting 0 ~ 2 function parameters are written periodically Operation status and frequency feedback of frequency inverter 0 ~ 2 monitoring parameters are read periodically
Standard telegram 3	PZD-6/6	Frequency inverter command and frequency setting 0 ~ 4 function parameters are written periodically Operation status and frequency feedback of frequency inverter 0 ~ 4 monitoring parameters are read periodically
Standard telegram 4	PZD-8/8	Frequency inverter command and frequency setting 0 ~ 6 function parameters are written periodically Operation status and frequency feedback of frequency inverter 0 ~ 6 monitoring parameters are read periodically
Standard telegram 5	PZD-10/10	Frequency inverter command and frequency setting 8 ~ 0 cycle write function Operation status and frequency feedback of frequency inverter 0 ~ 8 monitoring parameters are read periodically
Standard telegram 6	PZD-12/12	Frequency inverter command and frequency setting 0 ~ 10 function parameters are written periodically Operation status and frequency feedback of frequency inverter 0 ~ 10 monitoring parameters are read periodically

PZD is the process data. The master station of PZD can send instructions to the frequency inverter periodically and read the current status of the frequency inverter periodically. Each PZD can select configuration and select the parameters to be interacted between the master station and the slave station. PZD1 and PZD2 are fixed configuration and cannot be modified. The configuration of PZD3 ~ PZD12 can be changed according to the specific needs of users. The interactive data is shown in table 3.5

Table 3.4 Description of PZD interactive data

PZD (Master->Slave)		
PZD1	PZD2	PZD3~PZD12

Inverter command	Frequency command of frequency inverter	Other frequency inverter function parameters
PZD (Slave->Master)		
PZD1	PZD2	PZD3~PZD12
Inverter status	Frequency feedback of frequency inverter	Other monitoring parameters

Table 3.5 Description of data sent by master station

Master station sends data		
PZD1	Inverter control command 0: No command 1: Forward running 2: Reverse running 3: Forward jog 4: Reverse jog	5: Slow down and stop 6: Freely stop 7: Fault reset 8: Run forbidden command 9: Run allow command
PZD2	Frequency command of frequency inverter, unit: 0.01Hz	
PZD3~PZD12	It can be configured with different control parameters (0x3xxx group address) to issue periodic instructions to the frequency inverter	

Table 3.6 Description of data sent by slave station

Sending data from slave station		
PZD1	Bit0	0: Shutdown state, 1: running state
	Bit1	0: non accelerated state, 1: accelerated state
	Bit2	0: non deceleration state, 1: deceleration state
	Bit3	0: forward, 1: reverse
	Bit4	0: no fault, 1: fault
	Bit5	0: GPRS unlock, 1: GPRS lock status
	Bit6	0: no warning, 1: warning
PZD2	Frequency feedback of frequency inverter, unit: 0.01Hz	
PZD3~PZD12	It can be configured for different monitoring parameters (C00.xx group and part of 0x3xxx group address) to read data periodically from frequency inverter	

4 S7-1200 Configuration AC300PN1 Card Example

The following shows that S7-1200 is used with V15 to show how to configure with AC310 and AC300PN1 card.

Step 1: build a new project and add S7-1200 master station

Open the software and click create new project.

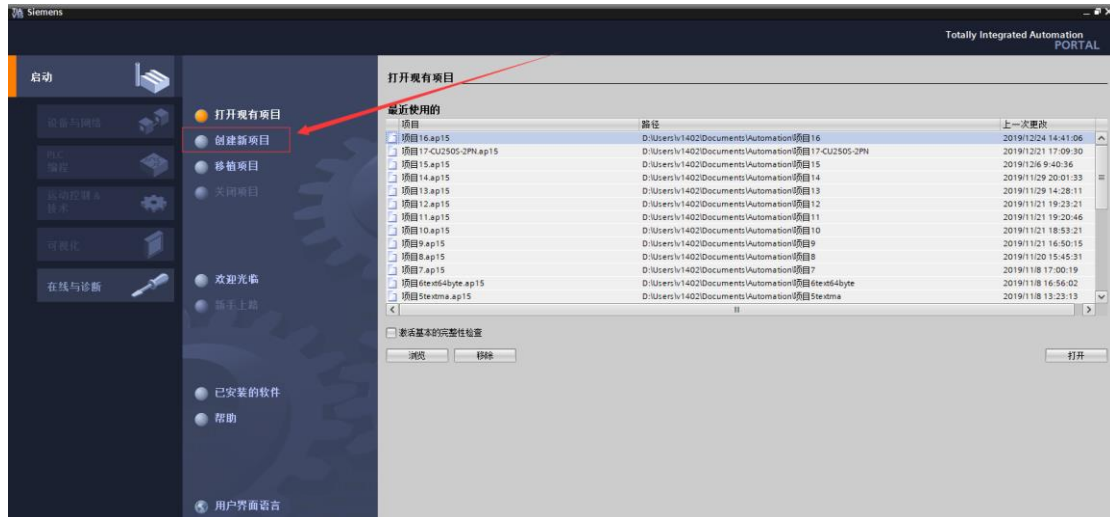

Fill in the project information, project name, path, etc. When finished, click to create.

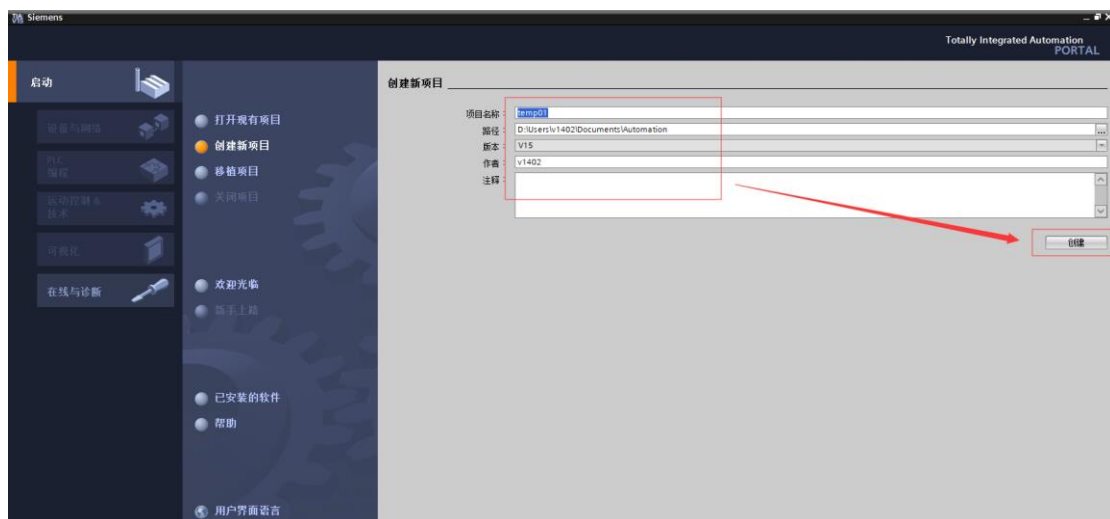

Click the configuration device.



Click the **Add device**. Select PLC corresponding model. Click to add.

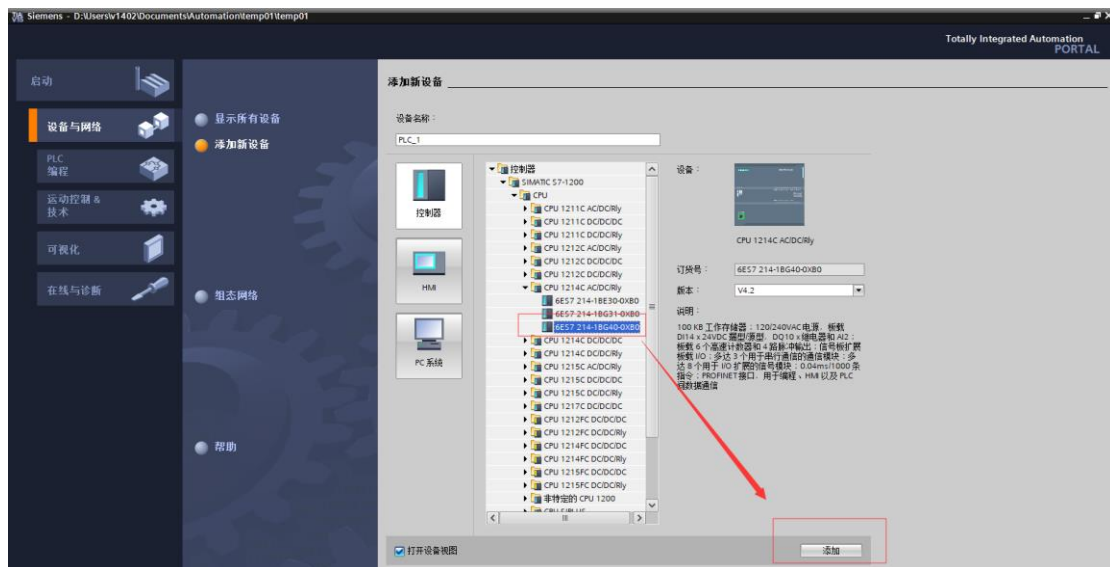

Step 2: import the GSDML file

In "options", click "manage general station description file"

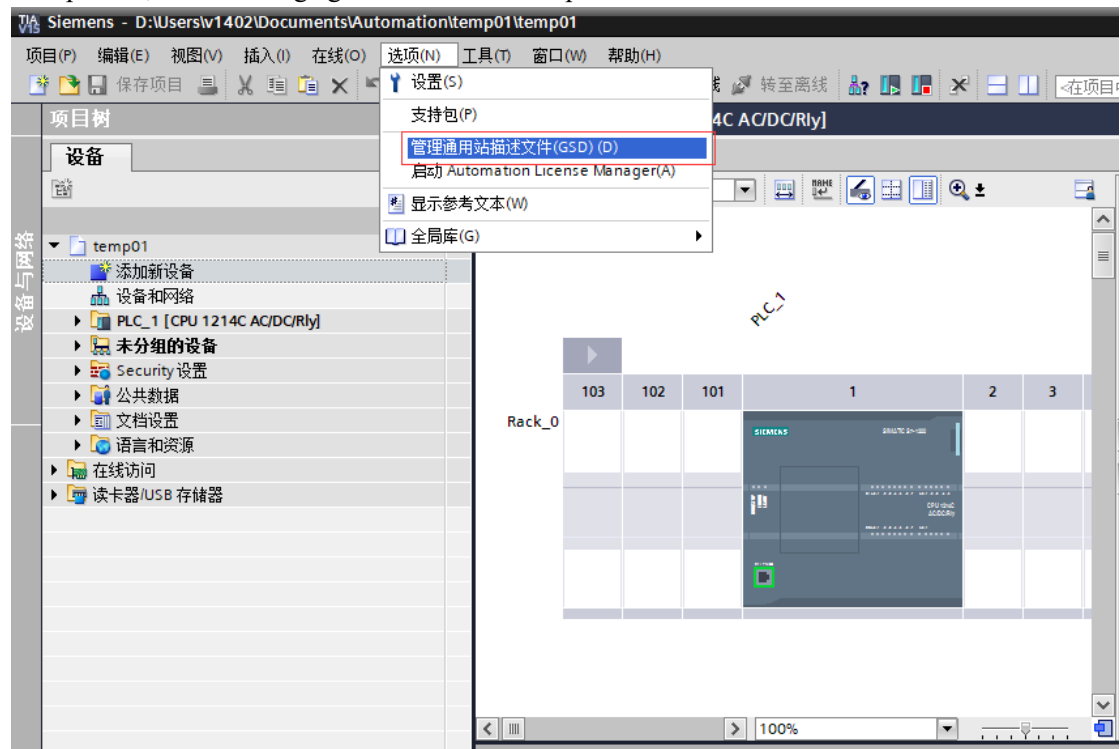

In the pop-up dialog box, first select the path where the GSDML file is stored (be careful not to put the GSDML file in the Chinese path, otherwise an error may be reported), and then select and click **Install**. The GSDML file can be obtained from the manufacturer or the official website

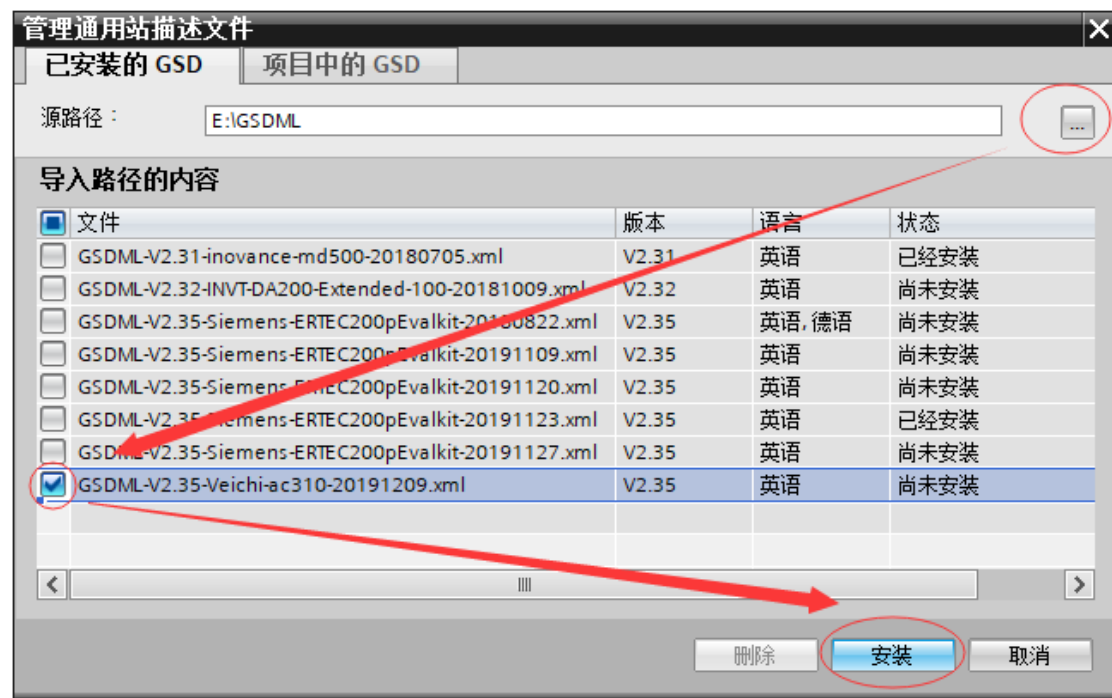

If the installation is successful, you will be prompted as follows. Click "close"

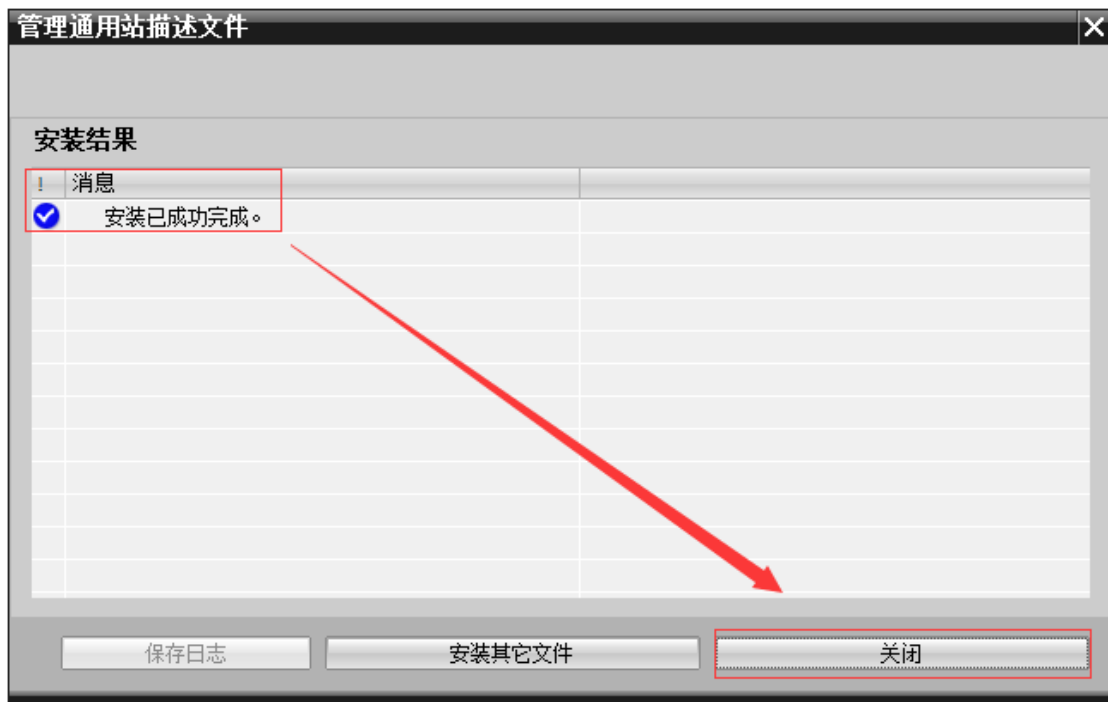

Step 3: configure the slave information

Double-click **devices and networks** in the project

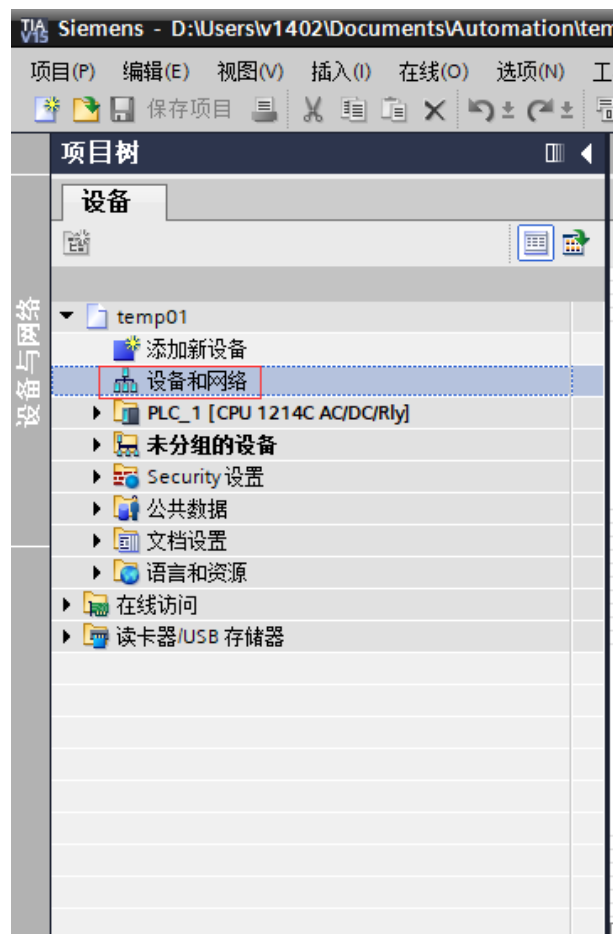

Select network view

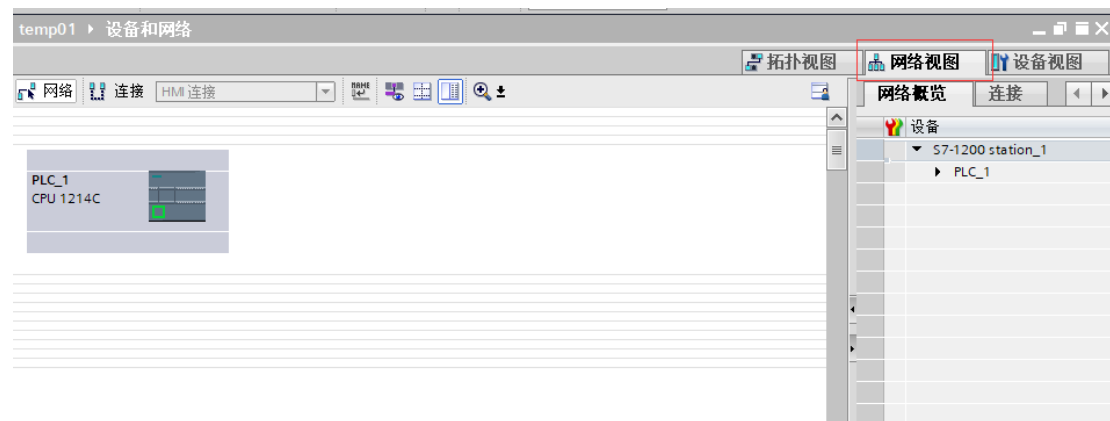

Find "other field devices" - "PROFINETIO" - "I/O" - "AC310" - "AC310PN" under the "hardware directory" on the right, and double-click "Standard, MRP"

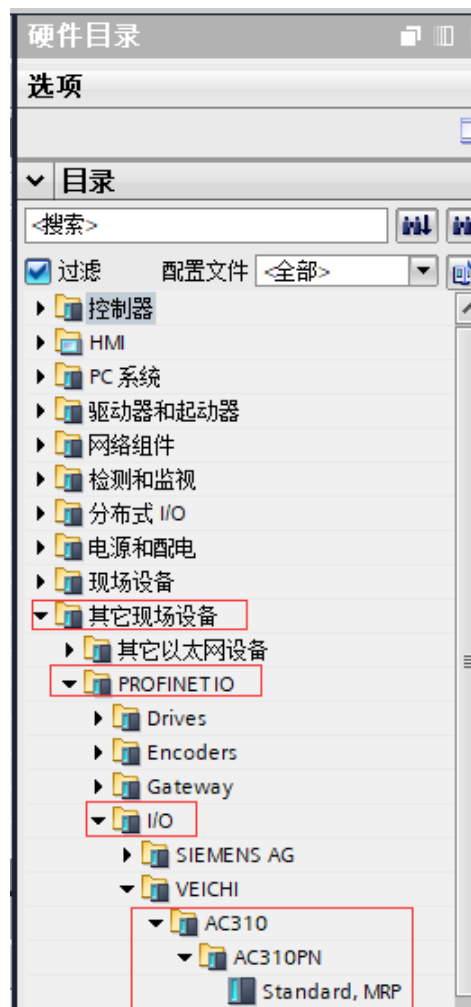

Select the Ethernet port of PLC, switch to "properties" – "Ethernet address", set IP address and subnet mask, and click "add subnet"

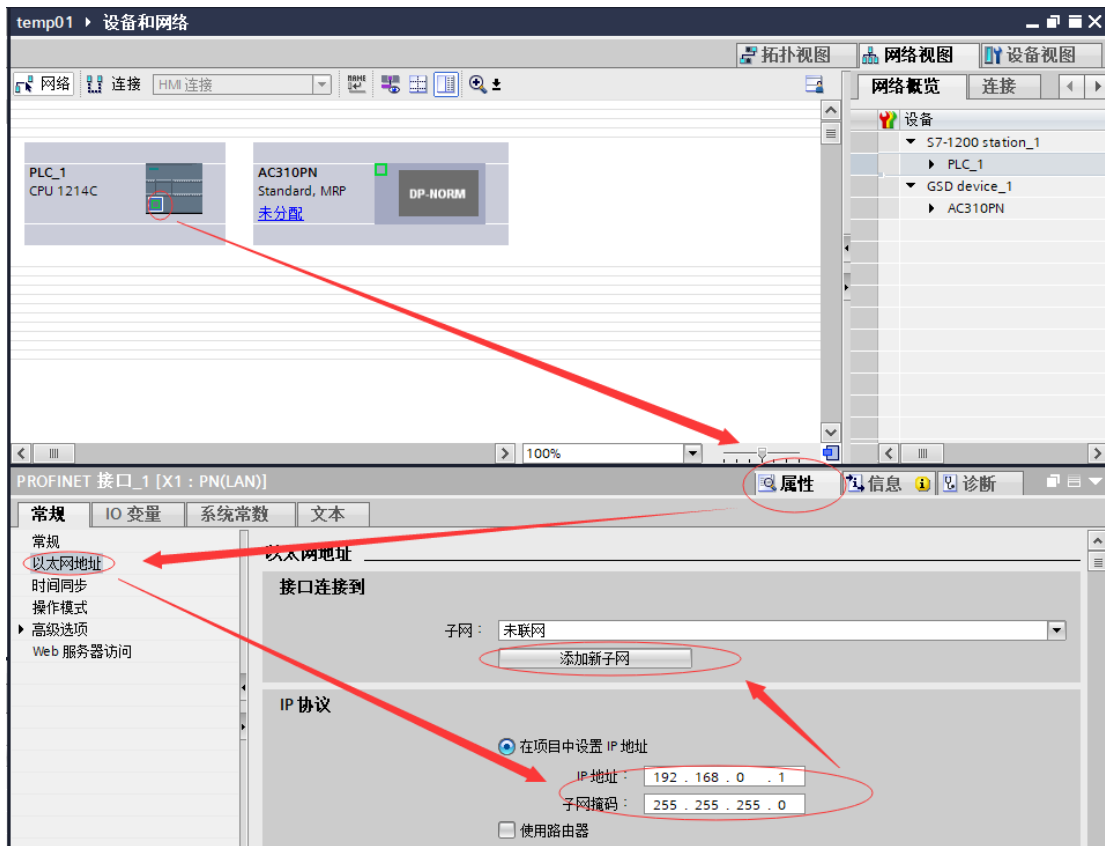

Click "unassigned" of AC310PN, and click "PLC_1. PROFINET interface_1"

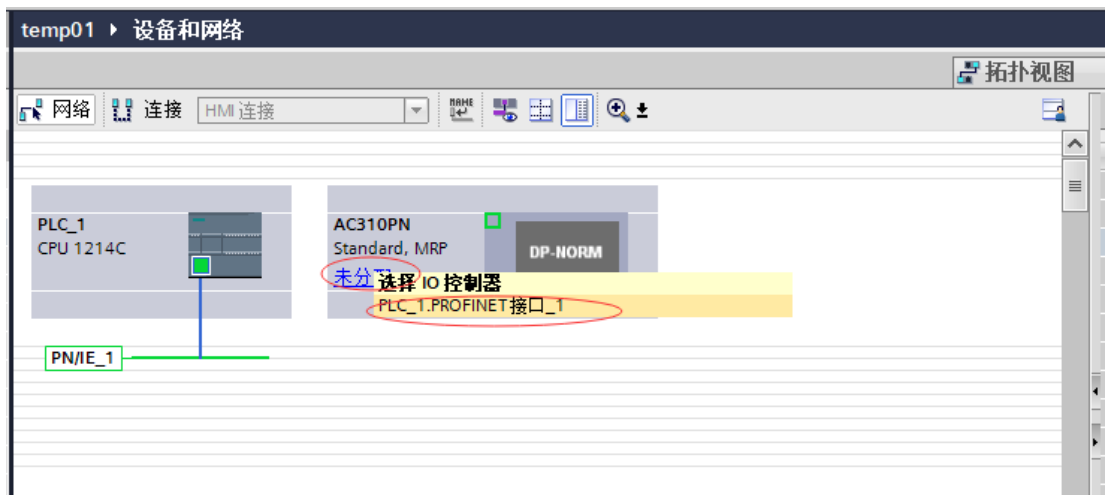

Select the slave station, click **"properties"** - **"Ethernet address"**, and set the IP address of the slave station. Under **"PROFINET"**, tick off **"automatically generate PROFINET device name"**, and enter the desired name (you can also keep the check box to let the system automatically generate the name)

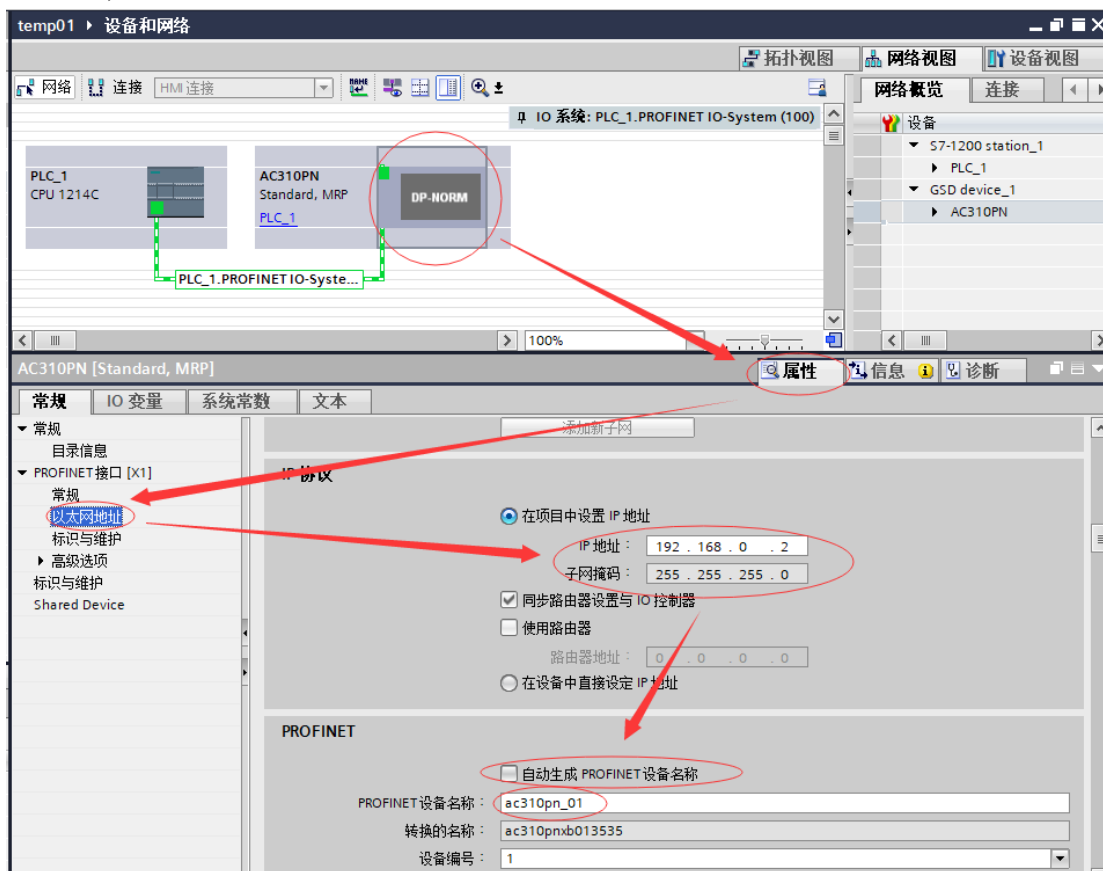

Step 4: select the interactive data station

Select the slave station, switch to the **"device view"**, expand the **"module"** in the right directory, and select the periodic interactive data according to the number of parameters to be sent and received. For example, if there are four parameters for the master station to send to the slave station and the master station to read the status of the slave station, select standard message 2

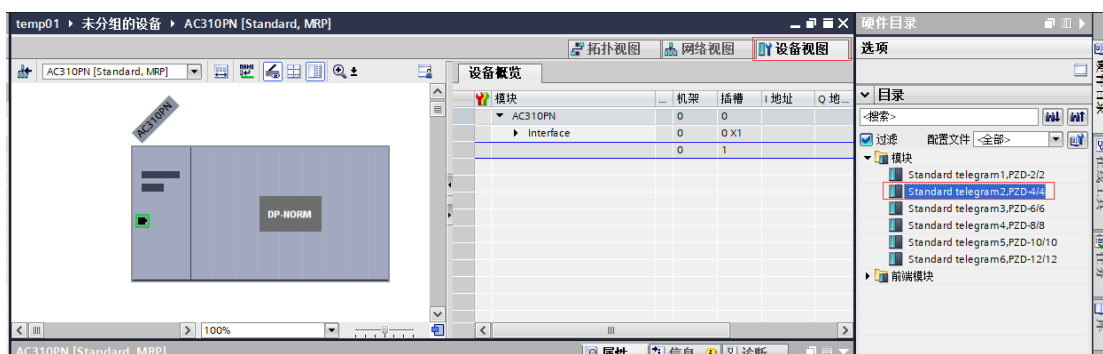

After that, select the message and click "properties"->"module parameters" to see the specific configuration of PZD. PZD1 and PZD2 are fixed configurations, PZD1 (Master > slave) and PZD2 (Master > slave) are the control commands and frequency given by the master station respectively. PZD1 (slave > Master) and PZD2 (slave > Master) are the state and frequency feedback of the frequency inverter, read by the master station. PZD3 (Master > slave) and PZD4 (master > slave) can select the command to send according to table 3.2, and 0xFFFF means invalid. PZD 3 (slave > Master) and PZD4 (slave > Master) can select the parameters to be monitored according to table 3.3, and 0xFFFF means invalid.

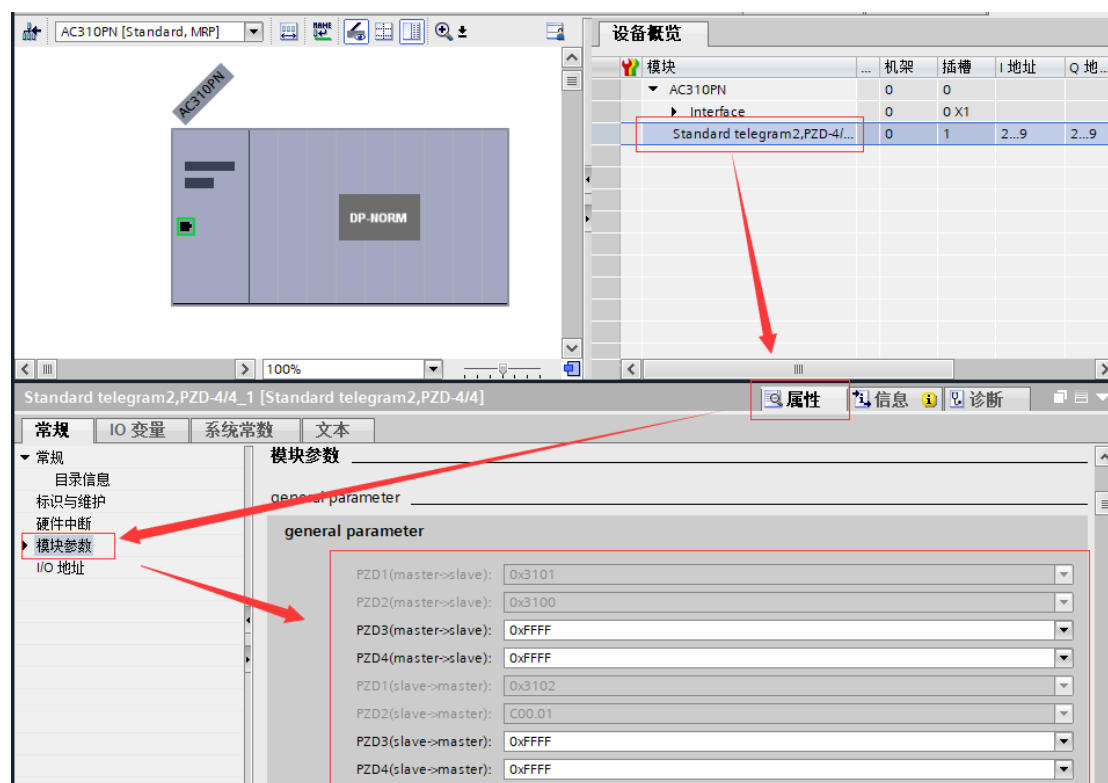

Switch back to the network view. If you need to add more slaves, repeat the above. If the configuration is the same, you can copy the slave directly, and then modify the IP address and device name

Step 5: download configuration Save the configuration, set the IP address of the computer and PLC in the same network segment (do not duplicate the IP address of the slave station), compile and click download

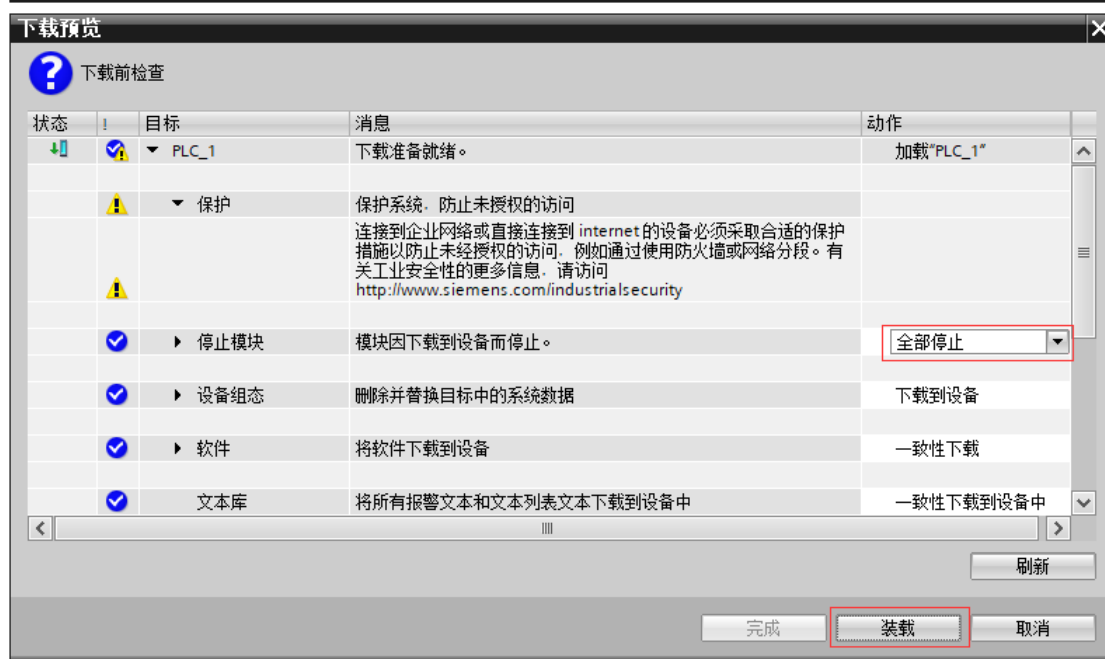
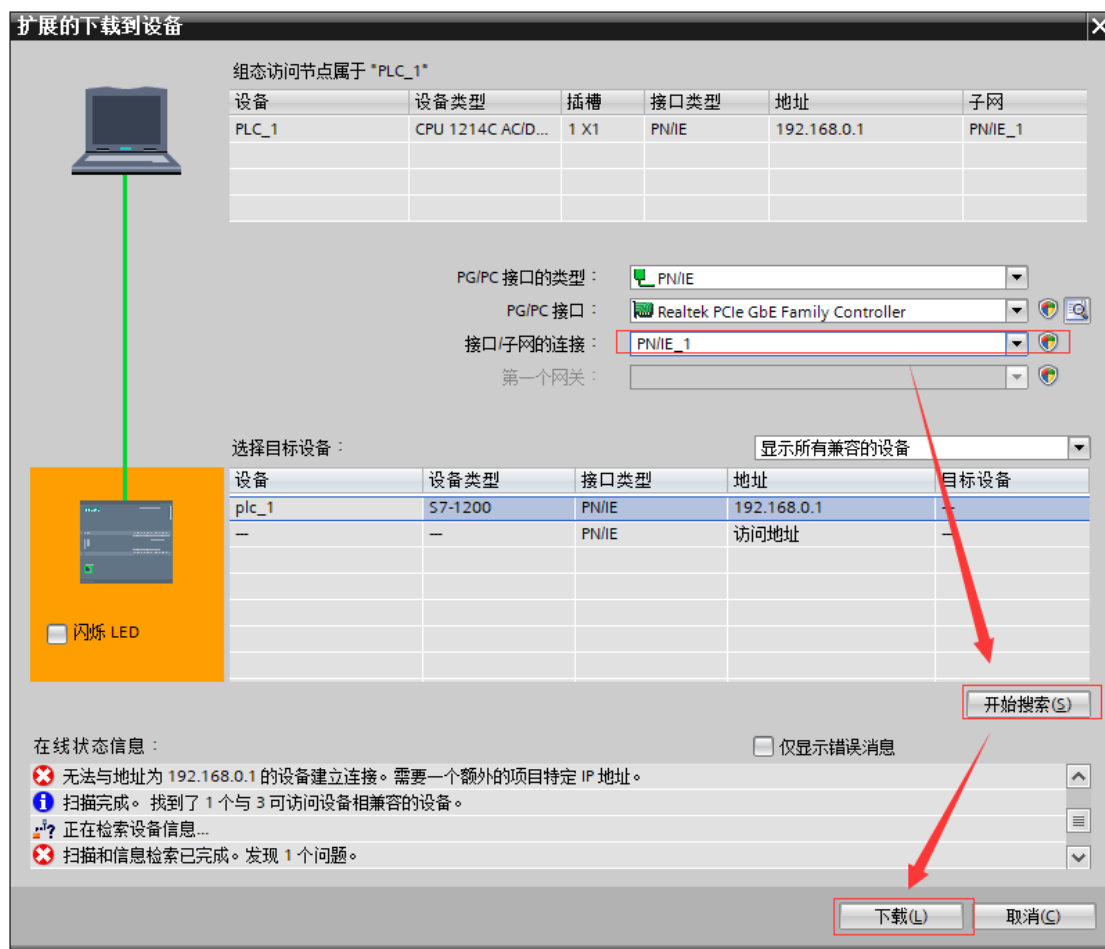

Step 6: assign device name

Select the slave station and click "online" - "assign device name"

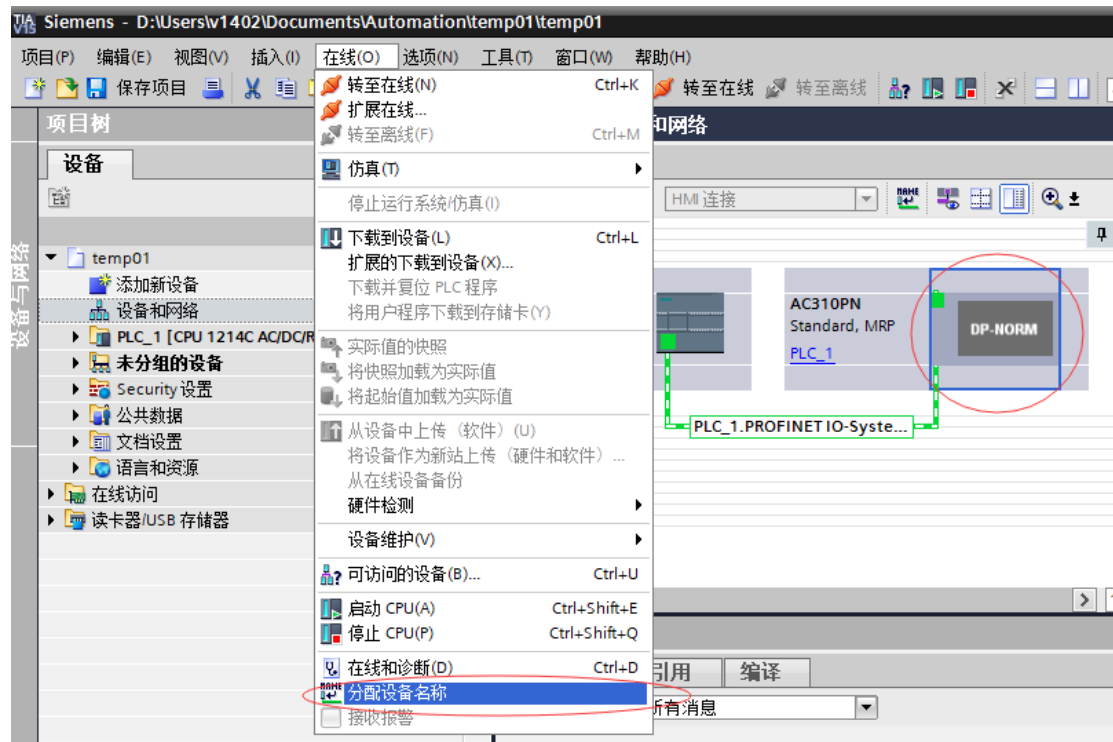

Click "**update list**", where the device name should be consistent with the name in "configured PROFINET device"

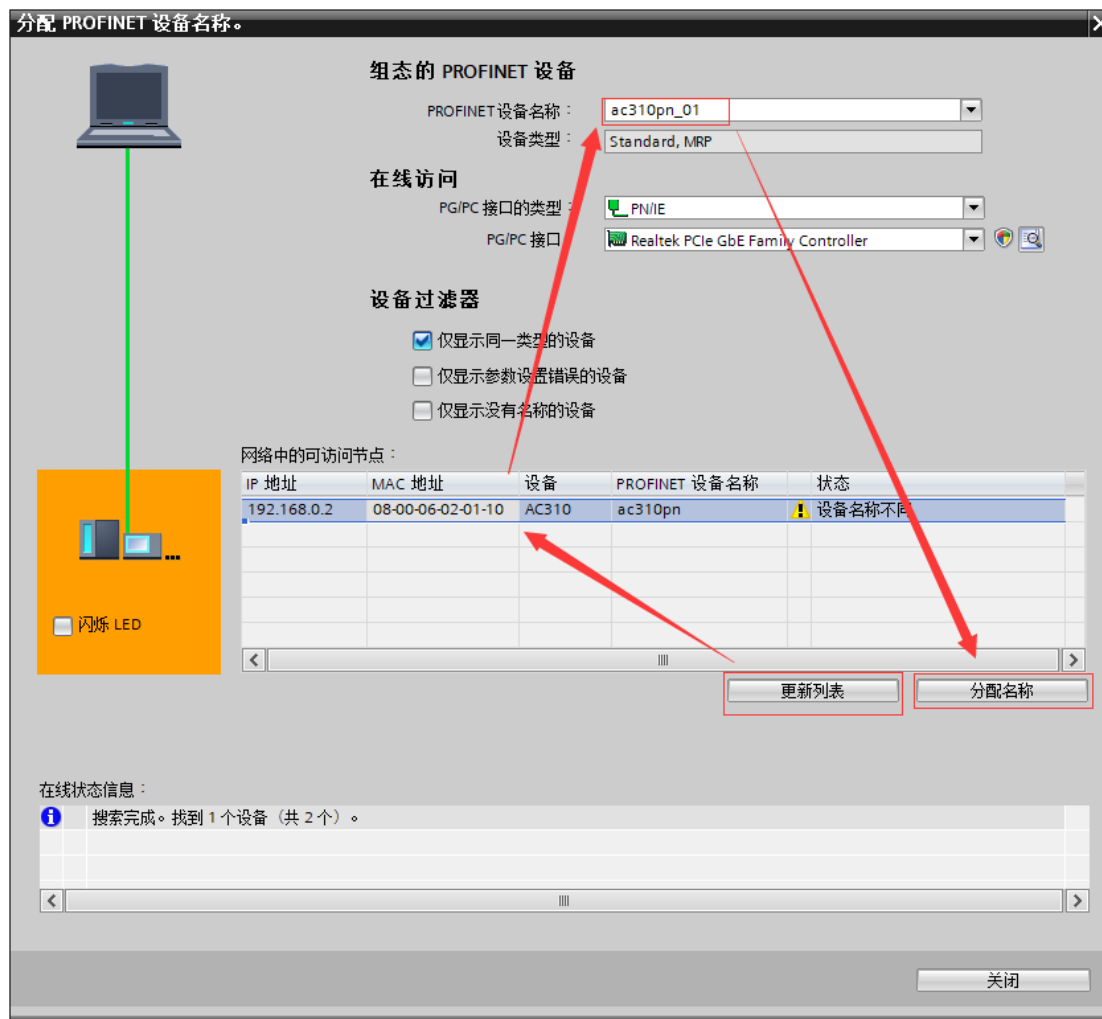

If there are more than one other devices, you can select other devices to assign the name. After receiving the assigned name, the slave station will save the name. The master station distinguishes each slave station by the device name. The essence of assigning the name is to bind the device name and MAC address. After modifying the name of the station device in the configuration, the name must be reassigned

After all the above operations are completed, PLC program can be written to control the inverter

5 AC300PN1 Card Fault Direct Replacement

When the fault of AC300PN1 card cannot be recovered, it can be replaced directly. It is only necessary to set the corresponding settings on the upper computer of PLC when configuration is needed, and there is no need to reconfigure the equipment

Replacement conditions:

1. The replacement AC300PN1 card has never been assigned a device name;
2. When PLC configures network, it configures topology network;
3. In PLC configuration, check "support equipment replacement without exchangeable media"

The following takes Portal V15 as an example to illustrate how to make settings that can be replaced directly

In the hardware configuration, select the PROFINET interface of the master station, and in the "advanced options" of the "properties", check "support equipment replacement without replaceable media". If you use S7-1200 or S7-1500, you can check "allow to cover all assigned IO device names", and the direct replacement condition 1 can be ignored

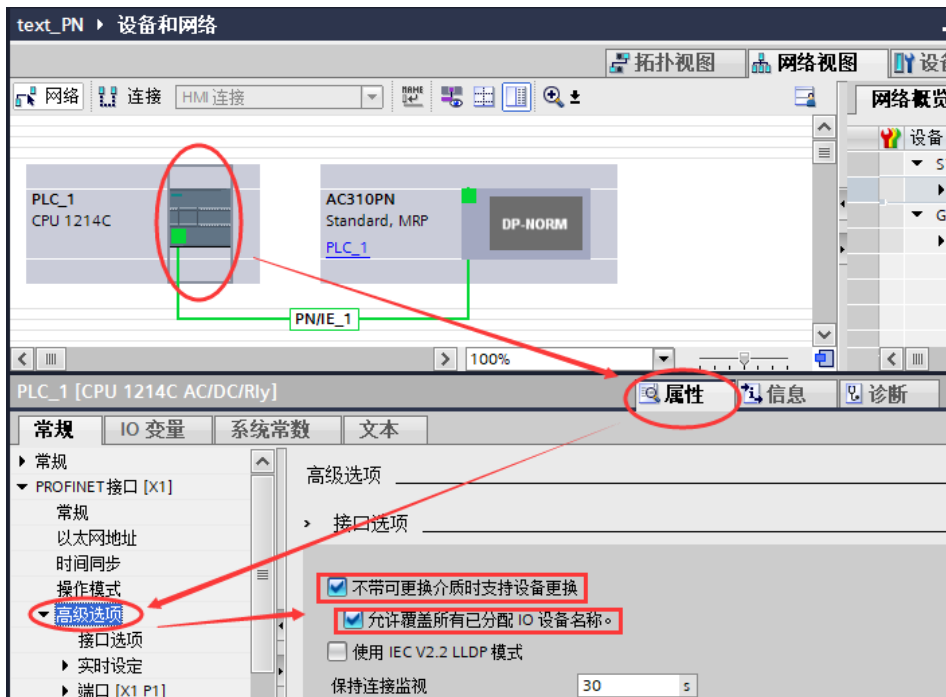

Switch to the "topology view", click on the PLC port, hold it down, and drag it to the port of AC300PN1 card which is directly connected with. Note here that the wiring in the topology view must be consistent with the actual physical network wiring. Facing RJ45 interface, P1 is on the right and P2 is on the left of the AC300PN1 card.

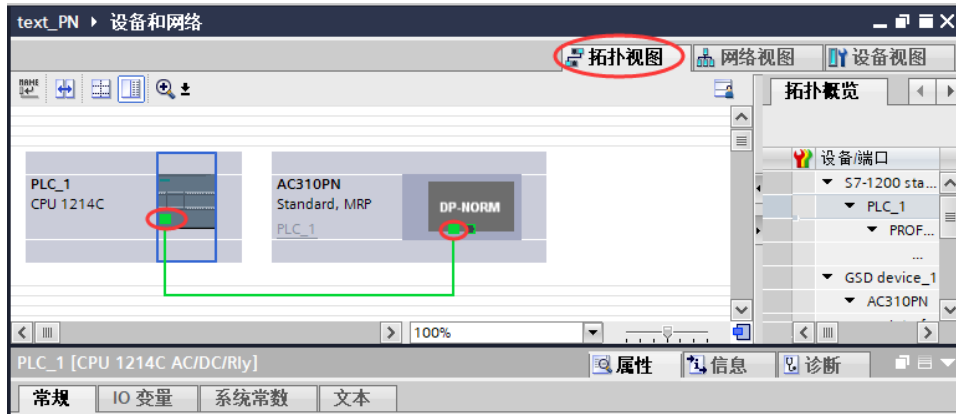

After connecting, compile and download to PLC

6 Others

1. When AC300PN1 card is used, please use super-5 or above shielded network cable for communication, so as to enhance the anti-interference ability of the equipment;
2. When AC300PN1 card is used, in order to ensure the accuracy and reliability of the signal, the distance of the communication network lines between the two cards should not exceed 100 meters. Due to the long wiring, the signal attenuation and anti-interference performance are reduced. It is recommended to use the switching unit network (as shown in Figure 3.2)
3. Try not to be parallel with the power line (R/S/T, U/V/W) as far as possible. If the wiring conditions are limited, please keep a distance of more than 0.5m when parallel routing;
4. Grounding the shielded network cable port can effectively reduce the interference

Thank you again for using AC300PN1 card!



Figure 6.1 Category 5 shielded network cable