



# Manual

**AC70E Series Frequency Inverter**

# FOREWORD

Thank you for using AC70E series inverter produced.

AC70E series inverter is a new generation of high-performance mini -frequency inverter independently developed,With advanced control method and rich function design. Users will be satisfied by the simplified PLC, PID adjustor, programming I/O terminal, RS485 interface, analog I/O terminal, and other specific control functions for particular industries in the benefit of AC70E

This manual is the supporting data sheet for AC70E

This instruction manual includes save tips, instructions (messages) of installing wiring, keyboard operation, simple function table, troubleshooting, maintenance only. For parameters setting detail, pls read AC70 general used series manual or consult us. For the best results and safe operations with the AC70 series, carefully read and keep this manual. Make sure it is handy for the ultimate user of the inverters for reference.

To receive technical support related to the inverter, please contact sales office or the dealer from whom you purchased. You can also contact our Customer Service Center, and we will try our best to help you.



We are sparing no effort to upgrade our products and regret not to issue prior notification if there is any revision to this instruction manual. Pray for your consideration for the inconveniences

# Chapter 1: Summarize

## 1.1 Safety requirements and cautions

To ensure safety of your health, equipment and property, please read this chapter carefully before use the frequency inverter and act in compliance with the instructions while carrying, installing, debugging, running and overhauling the frequency inverter.

### Warn sign and meaning

 Danger	<b>Danger: it will cause danger of serious injuries and even death while operating against the rules</b>
 Warn	<b>Caution: it will cause danger of light injuries or equipment destruction while operating against the rules</b>

### Qualified operation

Only qualified person after professional train can operate the equipment. The operator must be with professional train, familiar with installation, wiring, running and maintain of equipment, and can deal emergency case.

### Safe guide

Warn sign is for safe, to prevent operator from hurt and prevent this product and relating equipment from being damaged. Before operating, be sure to carefully read the manual about safety, installation, operation and maintenance and obey to the safe rules and warn sign.

- Right transport, store, installation and careful operation and maintenance is most important for inverter safe run. In transport and store process, make sure the inverter is free from impact and vibration. It must be stored where is dry, without corrosive air and conductive dust, temperature lower than 60°C.
- This product carries dangerous voltage and controls driver machine with potential danger. If not abide the regulations or requirements in this manual, there is danger of body injury even death and machine system damage.
- Do not wire while the power is conneted. Otherwise there is danger of death for electric shock. Before wiring, inspection, maintenance, please cut power supply of all related equipments and ensure mains DC voltage in safe range. And please do operation after 5 mins.
- Power wire, motor wire and control wire should be all connected firmly. Earth must be reliable and earth resistance must be lower than 10Ω.
- Human body electrostatic will seriously damage inner sensitive components. Before operation, please follow ESD measures. Otherwise there is danger of iverter damage.
- Inverter output voltage is pulse wave. If components such as capacitor what improves power factor and pressure-sensitive resistance for anti-thunder and so on are installed at the output side, please dismantle or change to input side.
- No switch components such as breaker and contactor at the output side. (If there must be one, please make sure the output current is 0 while the switch acting).
- No matter where the fault is, there is danger of serious accident, even human body injury what means dangerous malfunction possibility. So there must be additional external prevent measures or other safety devices, such as independent current limiting switch, machinery fense and so on.
- Only used in application fields as maker stated. No use in equipments related to special fields such as emergency, succor, ship, medical treatment, avigation, nuclear and etc.
- Only service department of the maker or its authorized service center or professional person trained and authorized by Veich can maintain the products. They should be very familiar with the safety warning and operation gist in this manual.

## 1.2 Before use

Pls check whether any package damage while receiving the product you ordered. If the package is ok, pls open it and check the inverter. If damage caused in transport, it is not duty of Veich company. But please contact Veich or the transport company immediately.

After checking the product, please also check if the model is the one you ordered. The model of the product is on the nameplate "MODEL" column. If any problem, please contact us freely.

Nameplate position and content

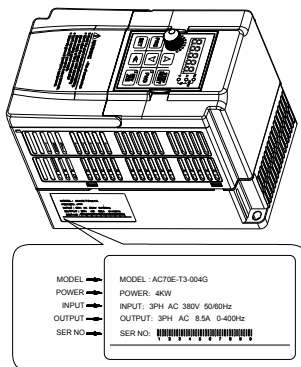

## Model explanation

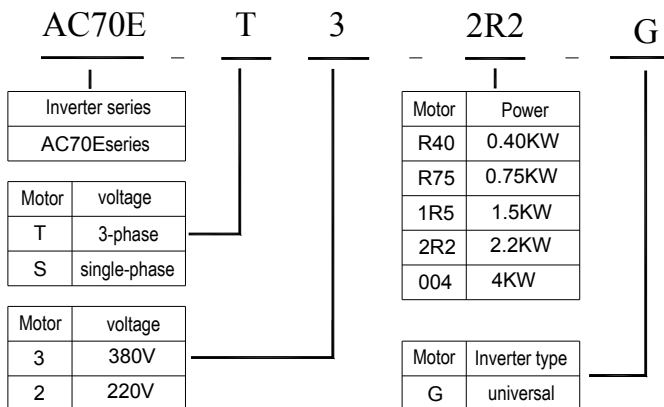

Single phase 220V			Three phase 380V		
Model	Max motor	Ratted current	Model	Max motor	Ratted current
AC70E-S2-R40G	0.4kW	2.5A	AC70E-T3-R75G	0.75kW	2.3A
AC70E-S2-R75G	0.75kW	4A	AC70E-T3-1R5G	1.5kW	3.7A
AC70E-S2-1R5G	1.5kW	7A	AC70E-T3-2R2G	2.2kW	5A
AC70E-S2-2R2G	2.2kW	10A	AC70E-T3-3R7G	3.7kW	8.5A

### 1.3 Product technique specifications

Items		Specifications
Power	Voltage/frequency	Single phase 220V 50/60Hz Three phase 380V 50/60Hz
	Allowable fluctuations	voltage: $\pm 15\%$ , frequency: $\pm 5\%$
Control	Frequency range	0-400Hz
	Frequency ACCuracy	$\pm 0.5\%$ of max frequency
	Frequency setting resolution	0.01Hz: Operating "up" and "down" keys on keyboard 0.2Hz: Potentiometers analog input
	Voltage/frequency characteristics	Voltage 50% -100% the rated voltage adjustable, Motor rated frequency 25-400Hz(2000Hz) adjustable
	Carrier frequency	1.0-15.0KHz/Random carrier modulation
	Torque upgrade	0-25.0% adjustable/auto torque upgrade/random V/F curve optional
	Maximum Capacity	150% for one minute, 180% for 2s, 200% instant jump.
	ACC and DECtime	0.1-6500s
	Rated output voltage	Take advantage of the power supply voltage compensation function, if motor rated voltage is 100%, the voltage can be set in the 50 -100% scope (the voltage output should not exceed the input voltage )
	AVR adjust	When the grid voltage fluctuates, changes in the output voltage is very small, remained constant V / F
	Automatic energy-saving operation	ACCording to the load conditions, automatic optimize the V / F curves to implement energy saving operation
	Standard functions	PID control, ACC and DECtime adjustable, ACC and DECmode variable, Carrier frequency adjustment, Torque upgrade, Current limiting, Speed tracking and restart, Frequency hopping, Frequency fluctuation limite control, Program running, Multi-steps speed, Pendulum frequency operation, RS485, Analog output, Pulse output frequency
	Brake	Energy-consuming braking, DC braking
	Frequency setting input	Keyboard number settings, keyboard potentiometers/ external terminal VS: 0-10V, the external terminal AS : 4-20mA, RS485 and signal composition and terminal options
	Signal Feedback input	External terminal VS: 0-10V external terminal AS: 4-20mA, RS485
	Input order signals	Start, stop, positive and negative rotating , jog, multi-steps speed, free parking, reset, ACC and DECtime choice, frequency settings channels choice, external malfunctions alarm
External output signal	Relay output, the collector output, 0-10V output, 4-20mA output, the frequency pulse output	
Protection function	Overvoltage, undervoltage, current limiting, over-current, overload, electric thermal relays, overheat, pressure stall, data protection	

Display	Setting	Function number/data
	Running	Output frequency, give frequency, output current, input voltage, output voltage, motor speed, PID feedback, quantitative PID, module temperature, input and output terminal
	Fault	Overvoltage, undervoltage, overcurrent, short circuit, phase missing, overload, heat, pressure stall, current limiting, data protection is damaged, current fault operating conditions, historical fault
Condition	Installation sites	Indoor, elevation of not more than 1000 m, no corrosive gases
	Temperature, humidity	-10—+40℃, 20%—90%RH(No condensation)
	Vibration	Below 20Hz less than 0.5g
	Storage Temperature	-25—+65℃
	Installation mode	Wall-mounted mode
	Protection degree	IP20
	Cooling Mode	Forced air-cooling

#### 1.4 Cautions in utilization



Frequency inverter is designed to be permit to run under industrial surrounding with electromagnetic interference. Usually, if install quality is good, it ensures frequency inverter safe run without fault. Pls install according to below rules to ensure reliable run and avoid the impact of electromagnetic interference.

- Ensure all equipments connected to frequency inverter are connected to star earth or common earth bus by short and thick cable as well as frequency inverter. Motor earthing should be as close as possible. Do not connect motor cruster to earth terminal of frequency inverter or protection earth of control system.
- Conductor should be flat/ multi cores what has lower impedance at high frequency.
- Cut cable neatly to ensure unshield cable as short as possible.
- Control wire should be away from the supply cable and motor cable as far as possible and use independent wire slot. While it must across to the supply cable and motor cable, should be 90° vertical across.
- Ensure that the contactor in the cabinet has wave surge suppresser.Or'R-C'damping circuit is connected to the winding of AC contactor. Voltage dependent resistor corresponding to the winding voltage is used. And freewheel diode or components such as voltage dependent resistor corresponding to the winding voltage are connected to DC contactor. It is very important while contactor, controlled by output relay of inverter, acts frequently.
- Cable connected to motor should be shielded cable or armoured cable. The two barriers are earthed reliably by cable grounding card.
- Build noise filter at the input side to reduce electromagnetic interference from other equipments at the power grid side. The noise filter should be as close to the inverter power input terminal as possible. Meantime, the filter must earth reliably as the inverter.
- Build noise filter at the output side to reduce radio interference and inductive disturbance. The noise filter must be as close to the inverter output terminal as possible. Meantime, the filter must

earth reliably as the inverter.

- Anytime, control circuit wire should be shielded cable.
- Add zero phase reactor in power supply wire near inverter input terminal and add zero phase reactor in the motor wire near inverter output terminal to reduce electromagnetic interference to the inverter efficiently.
- Earthing

Right and reliable earthing is the basic condition of safe and reliable running of the product. For right earthing, please read the following notice carefully.

	<ul style="list-style-type: none"><li>● In order to avoid electric shock, earthing cable should be the size as electric equipment technic standard required and cable length should be as short as possible. Otherwise inverter leakage current will causes unstable potential of the earthing terminal which is far from the earthing point. Electric shock accident will happen frequently.</li><li>● Earth terminal must earth. Earth resistance must be below 10Ω. Otherwise there is danger of death.</li></ul>
	<ul style="list-style-type: none"><li>● Please do not share earth cable with welder or other big current/pulse power equipment. Otherwise inverter will act abnormally.</li><li>● While multi inverters are using at the same time, please do not wind the earth wire to loop-type. Otherwise inverter will act abnormally.</li></ul>

# Chapter 2: Installation

## 2.1 Inverter stable running environment

Install environment is very important to the best use of this product for long time. Pls install this product in the enviroment as the folling chart requirement.

Environment	Requirement
Install place	Indoor without direct sunshine
Install temperature	-10~+40 °C (hanging type) -10~+45 °C (cabinet type)
Store temperature	-20~+60 °C
Humidity	<95%RH, no condensation
Surrounding	Please install the inverter in place as below: <ul style="list-style-type: none"> <li>● Place without oil mist, corrosive gases, flammable gases, fust or etc.</li> <li>● Place without metal dust, oil, water or etc into inverter (please do not install inverter on flammable material such as food and etc).</li> <li>● Place without radioactive material or flammable material.</li> <li>● Place without poisonous gases or liquid.</li> <li>● Place with very little salification erosion.</li> <li>● Place whihout direct sunshine.</li> </ul>
Altitude	<1000m
Vibration	<10~20Hz: 9.8m/s <sup>2</sup> <20~55Hz: 5.9m/s <sup>2</sup>
Installation and cooling	<ul style="list-style-type: none"> <li>● Inverter can not be installed horizontally, must be installed vertically.</li> <li>● Please independently install high heating equipments such as braking resistor and etc which can not be installed in the same cabinet with inverter, stalled at the air-in port of the inverter is strictly prohibited.</li> </ul>

## 2.2 Installation notice and related requirement

- AC70E inverter components

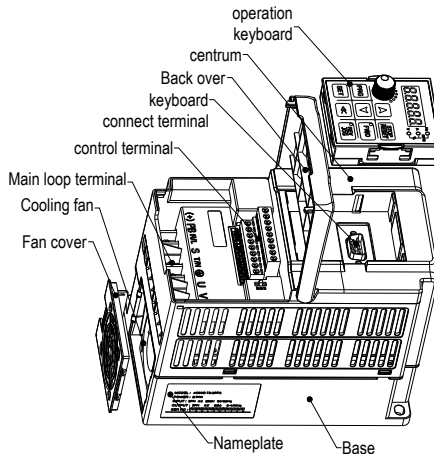



- Installation direction and space

Single machine installation: to ensure enough ventilation and wiring space for inverter cooling, please follow installation conditions as below. It should adopt hanging style or closet style with upright installation and keeps enough space with surroundings or the wall.

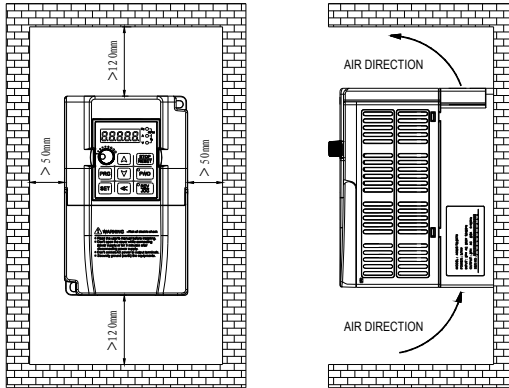

Single machine installation

Multi inverters paratactic installation: while install multi inverters in cabinet, please ensure installation space as below.

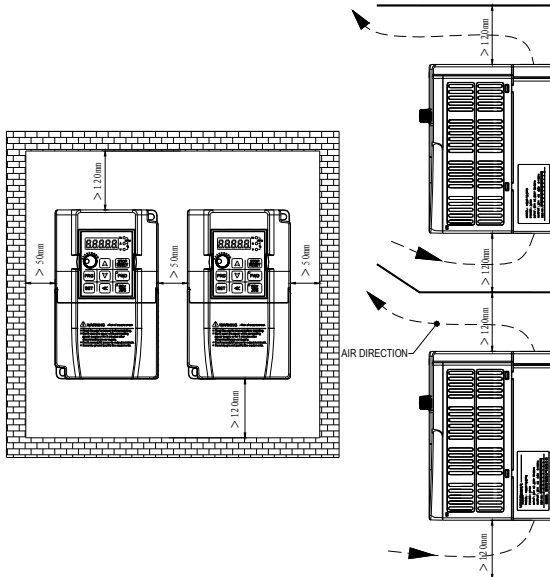

More inverters paratactic installation

## 2.3 Dimension of inverter and keyboard

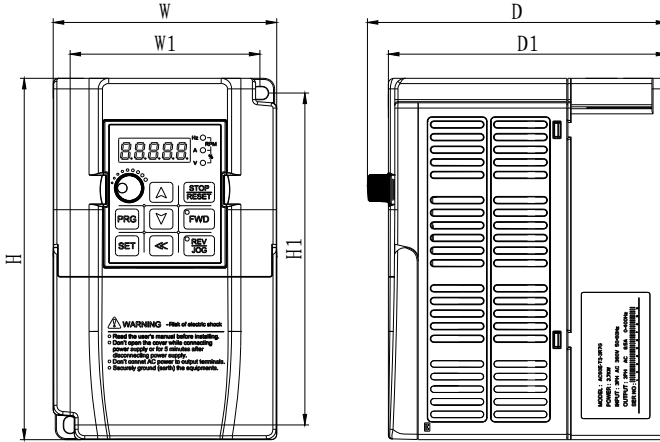

MODEL	W	W1	H	H1	D	D1	INSTALLATION APERTURE
AC70E-S2-R40G	88	75	142.5	129.5	142	132	φ5
AC70E-S2-R75G							
AC70E-S2-1R5G							
AC70E-T3-R75G							
AC70E-T3-1R5G	106	90	172	158	142	132	φ6
AC70E-S2-2R2G							
AC70E-T3-2R2G							
AC70E-T3-3R7G							

## 2.4 Keyboard dimension (unit: mm)

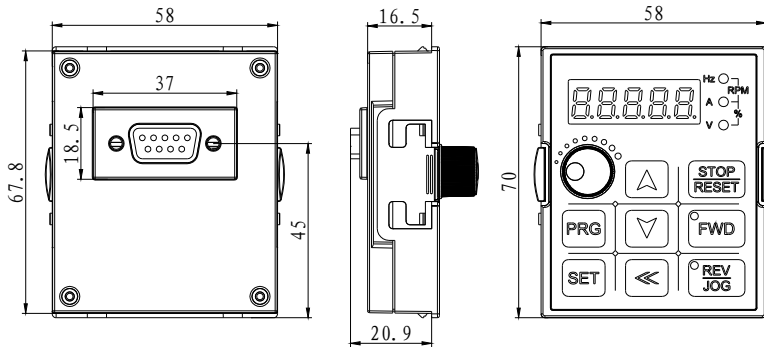

## 2.5 Electric installation

This chapter explains the regulations that users have to obey aimed to ensuring safe use, best performance and reliable running.

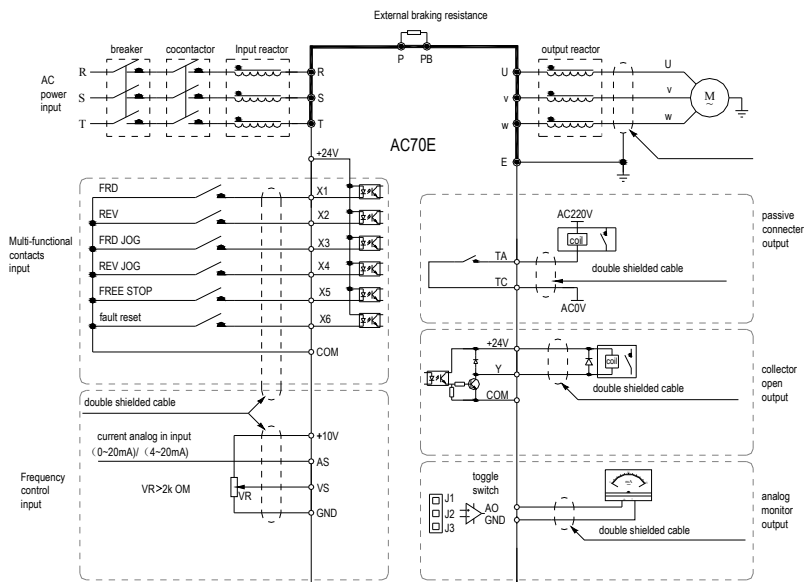

Note: Analog monitor output is special output of meters such as frequency meter, current meter, voltage meter and etc. It can not be used for control operations such as feedback control.

### ● Switch terminals connection function specification

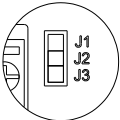
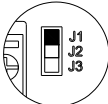
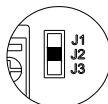
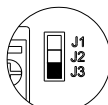
Switch terminal	Selectable	Picture example	Function specification
	J1		0.2–10kHz frequency output
	J2		0–20mA current output 4–20mA current output
	J3		0–10V voltage output

● Suggested braking resistance

Single-phase 220V				Single-phase 220V			
Motor power	Resistance value	Resistance power	Braking moment	Motor power	Resistance value	Resistance power	Braking moment
0.4 kW	400Ω	100W	100%	0.75 kW	750Ω	150W	100%
0.75 kW	200Ω	120W	100%	1.5 kW	400Ω	300W	100%
1.5 kW	100Ω	300W	100%	2.2 kW	250Ω	400W	100%
2.2 kW	75Ω	300W	100%	3.7 kW	150Ω	500W	100%

● Main circuit terminals

Terminal	Name	Function definition
(+)	Braking resistance terminal	Used for external braking resistance to realize quick stop.
PB		
R/L	AC input terminal	Used to connect AC power supply (R/L, S, T/N for T3 AC input; R/L, T/N for S2AC input).
S		
T/N		
U	AC output terminal	Used to connect the motor or other sensitive/resistive load.
V		
W		
⊕	Earth	Earth terminal, earth resistance < 10 OHM

● Control loop terminals







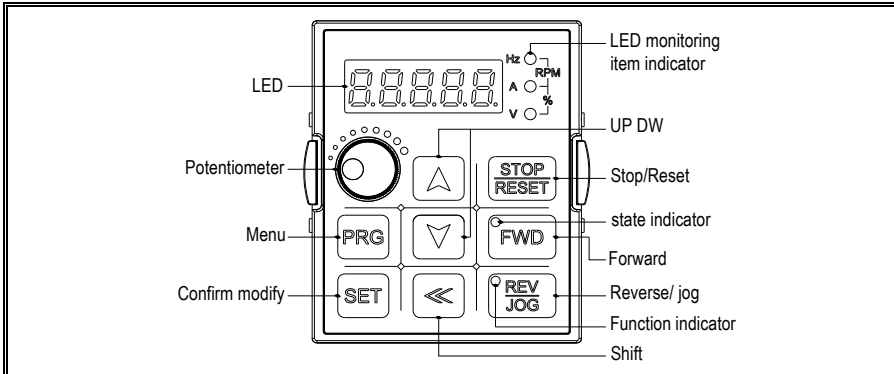

Terminal	Name	Function definition
TA	Normally-open	Can set the action and object by programme.

TC	contact	Max contact capacity: 3A/240VAC
Y	Collector open output	Can set the action and object by programme. Max contact capacity:DC30V/50mA
+24V	Auxiliary power output +	Max output: 24VDC/100mA。
COM	Auxiliary power output -	
FWD	Forward	Short connect with (COM) valid.
REV	Reverse	Short connect with (COM) valid.
X1	Multi function contact input X1	Short connect with (COM) valid. Multi function input terminals can be programme set definition. Pls refer F-01--F-04
X2	Multi function contact input X2	
X3	Multi function contact input X3	
X4	Multi function contact input X4	
AO	Analog output	Physical type of output signal: 0--10V 0--20mA 4--20mA frequency pulse output, selectable by function F-61/F-62 or switch J1 J2 J3.
AS	Current analog input	As inverter control signal or feedback signal, can set the act range and response speed by programme. VS resistance: 89KΩ, AS resistance: 250Ω.
VS	Voltage analog input	
+10V	Signal auxiliary power terminal	Max output 10VDC/50mA.
GND	Signal auxiliary power terminal	Common auxiliary power of analog output, analog input signal.
A+	Communication terminal A+	RS485 communication port
B-	Communication terminal B-	

# Chapter 3: Keyboard and Operation

## 3.1 Keyboard layout and function specification



Key	Key name	Key functions
	Menu key	Enter menu while standby or running. Press this key to return while modify parameter. While standby or running, press for 1 sec to enter monitoring interface.
	Confirm/modify key	Press to modify parameter while in menu interface. Press again to confirm after modify. While standby or running, press to change LED monitoring items at stop
	Up/down key	Select parameter group in menu interface. Modify parameter while in modify interface. Modify given frequency or PID or given torque while at standby or monitoring state (While given frequency or PID or given
	Shift key	Select digit of function no modified by up/down key; Select parameter digits modified by up/down key. Change LED monitoring items while standby or running
	Forward key	While run/stop is controlled by keyboard, press this key, the inverter forward rotate.
	Reverse/ jog key	While run/stop is controlled by keyboard, press it, machine will reverse if this key is defined as REVERSE and machine will jog if this key is defined as JOG.
	Stop/Reset key	Machine stops if press it while run/stop is controlled by keyboard. Its efficiency range is defined via function no F-07. Inverter reset if press it in fault state (no reset if fault is not solved)
	Potentiometer key	Can be used to adjust given frequency while it set as potentiometer adjust speed.

### 3.2 Indicating lamp meaning specification

	Name	State	Meaning
Unit indicators	Hz	Flashing	display value is given frequency.
	Hz	On	display value is output frequency.
	A	On	display value is output current actual value.
	V	On	display value is input voltage.
	V	Flashing	display value is output voltage.
	RPM	On	When "Hz" indicator and the "A" indicator light at the same time, display value is the motor speed.
	%	Flashing	When the "A" indicator and the "V" indicator flashing at the same time, display value is gived PID value.
	%	On	When the "A" indicator and the "V" indicator light at the same time, display value is the amount of PID feedback.
stateindicators	FWD	On	Frequency inverter turns forward.
	FWD	Flashing	Frequency inverter reverses.
	FWD	Off	Frequency inverter is close-down
Function indicators	REV/JOG	On	This key is defined as the jog function key.

## Chapter 4: Functional Parameter Table

Here only simple parameter table. For details, pls read AC70 series manual or consult us.

“●”: Means that the parameter can be revised during frequency inverter in a running state.

“○”: Means that the parameter can not be revised during frequency inverter in a running state.

“×”: Means that the parameters can only be read and can not be changed.

“-”: Means that the parameter is only set by the manufacturer.

“※”: Means that the parameter is related to the type of the frequency inverter

### 4.1 Basic parameter

Code function	Function name	Setting range and definition	Factory default	property	Communication code
E-00	Control method selection	0: Open loop vector control without PG 1: V/F control mode	1	○	100H
E-01	Running control command channel selection	0: Operator keypad 1: External terminal control 2: RS485 Communications port control	0	○	101H
E-02	Frequency reference given main channel selection	0: Operator keypad digital given 1: Potentiometer of keypad 2: Terminal VS1 analog voltage 0-10V 3: Terminal AS analog current signal 4~20mA 4: Reserve 5: Reserve 6: RS485 communication port 7: Up and Down control 8: General PID operation 9: Constant pressure PID control 10: Program running 11: Swing frequency run 12: Terminal selection:	1	○	102H
E-03	Frequency reference given auxiliary channel selection	0: Operator keypad digital 1: Potentiometer of keypad 2: Terminal VS1 analog voltage 0-10V 3: Terminal AS analog current signal 4~20mA 4: Reserve 5: Reserve 6: RS485 communication port 7: Up and Down control 8: General PID operation 9: Constant pressure PID control 10: Program running	0	○	103H



E-04	Frequency reference given channel gain	0.01 ~ 5.00	1.00	○	104H
E-05	Frequency reference given channel combination mode	0: Main channel is valid, auxiliary channel is invalid. 1: Auxiliary channel valid, main channel invalid 2: Both channel is valid if non zero value, main channel priority 3: Main channel + K×auxiliary channel) 4: main channel - (K×auxiliary channel) 5: MAX [main channel, (K×auxiliary channel)] 6: MIN [main channel, (K×auxiliary channel)] 7: Auxiliary channel + (K×main channel) 8: Auxiliary channel - (K×main channel) 9: MAX [(K×main channel), auxiliary channel] 10: MIN [(K×main channel), auxiliary channel]	0	○	105H
E-06	Upper LED monitor selection	0: Frequency Given 1: Output frequency 2: Output current 3: Input voltage	0	●	106H
E-07	Reserve	4: Output voltage 5: Machine speed 6: PID given given 7: PID feedback value		●	107H
E-08	REV/JOG key of keypad function selection	0: Reverse 1: Jog	0	●	108H
E-09	Maximum frequency	0.01 ~ 600.00Hz	50.00Hz	○	109H
E-10	Upper limit frequency	lower limit frequency ~ maximum frequency	50.00Hz	●	10AH
E-11	Lower limit frequency	0.00 ~ Upper limit frequency	0.00Hz	●	10BH
E-12	Lower limit frequency running mode	0: Stop 1: running with lower limit frequency	1	●	10CH
E-13	Acceleration time 1	0.1 ~ 6500.0s	※	●	10DH
E-14	Deceleration time 1	0.1 ~ 6500.0s	※	●	10EH

E-15	Acceleration /deceleration mode selection	<b>LED unit digit: decelerate /decelerate mode.</b> 0: linear accelerate 1: S curve <b>LED tens digit:</b> <b>Accelerate/decelerate time datum point.</b> 0: Motor rated frequency 1: Maximum frequency <b>LED hundreds digit:</b> <b>Equidistance stop function</b> 0: Disable 1: Enable <b>LED Thousands digit:</b> 0: Disable 1: Enable	0000	●	10FH
E-16	Frequency given by digital keypad	lower limit frequency~Upper limit frequency		●	110H
E-17	V/F curve mode	0: Constant torque curve 1: Descend torque curve (1.5 power curve) 2: Descend torque curve (1.7 Power curve) 3: Descend torque curve (2.0 Square curve) 4: User define curve	0	○	111H
E-18	Torque boost	0.0%~25.0%	※	●	112H
E-19	Filter time constant	0.01~99.99	※	●	113H
E-20	Carrier frequency	0.7KHz~15.0KHz	※	●	114H
E-21	Carrier characteristic	<b>LED unit Digit: Associate of carrier frequency and output frequency configure.</b> 0: Output frequency associate is disabled. 1: Output frequency associate is enabled. <b>LED tens digit: Associate of carrier frequency and module temperature configure.</b> 0: Module temperature associate is disabled. 1: Module temperature associate is enabled. <b>LED Hundreds digit: PWM mode selection</b> 0: Fixed PWM mode 2: Random PWM mode 1 <b>LED Thousands digit: Inhibition of shock</b> 0: Inhibition of shock is disabled 1: Inhibition of shock is enabled	1010	●	115H
E-22	V/F slip compensation	0%~200%	100%	○	116H

E-23	Energy saving mode selection	<b>LED unit digit: Auto energy saving selection</b> 0: disable 1: enable <b>LED tens digit: V/F slip compensation</b> 0: Disable 1: Enable <b>LED hundreds digit: Reserve</b> <b>LED thousands digit: Overmodulation</b> 0: Overmodulation allow 1: Overmodulation not allow	1000	○	117H
E-24	Voltage auto regulation function	0: Disable 1: Enable in full process 2: Disable only in deceleration	2	●	118H
E-25	Jog frequency	0.50Hz ~ upper limit frequency	5.00Hz	●	119H
E-26	Jog acceleration time	0.1 ~ 6500.0s	2.0s	●	11AH
E-27	Jog deceleration time	0.1 ~ 6500.0s	2.0s	●	11BH
E-28	Starting frequency	0.00 ~ 60.00Hz	0.50Hz	○	11CH
E-29	Starting frequency holding time	0.0 ~ 20.0s	0.0s	○	11DH
E-30	Starting mode selection	<b>LED unit digit: Starting mode selection.</b> 0: Starts from starting frequency 1: DC braking first, and then start from starting frequency 2: Restart after speed search <b>LED tens digit: Reserve</b> <b>LED Hundreds digit: Speed search direction</b> 0: Speed search performs only in running direction 1: bi-direction speed search <b>LED Thousands digit: Speed search mode</b> 0: Software speed search 1: Hardware speed search	※000	○	11EH
E-31	Power off restart selection	0: Disalbe 1: Enalbe	0	●	11FH
E-32	Power off restart waiting time	0.0 ~ 10.0s	0.5s	●	120H
E-33	Free stop frequency	0.00 ~ 60.00Hz	0.00Hz	●	121H
E-34	Stop mode	0: Deceleration stop 1: Free stop	0	●	122H
E-35	DC braking current	0 ~ 150%	50%	●	123H
E-36	DC braking time when stop	0.0 ~ 30.0s	0.0s	●	124H
E-37	DC braking starting frequency when stop	0.00 ~ 60.00Hz	0.00Hz	●	125H

E-38	DC braking time when start	0.0~10.0s	0.0s	●	126H
E-39	Jump frequency 1	0.00~600.0Hz(Fmax)	0.00Hz	●	127H
E-40	Jump frequency 2	0.00~600.0Hz(Fmax)	0.00Hz	●	128H
E-41	Jump frequency 3	0.00~600.0Hz(Fmax)	0.00Hz	●	129H
E-42	Jump frequency range	0.00~5.00Hz	0.00Hz	●	12AH
E-43	Number of auto restart attempts	0: Disable 1~3: Enable	0	●	12BH
E-44	Fault auto reset waiting time	0.1~20.0s	1.0s	●	12CH
E-45	Machine warm up time	0.0~6500s	0.0s	●	12DH
E-46	Running direction selection	0: Consistent with the default direction 1: Opposite to the default direction 2: Reverse running forbidden.	0	○	12EH
E-47	FOR/REV dead zone time	0.0~10.0s	0.0s	●	12FH
E-48	Cooling fans running selection	0: Fan runs when switch on. 1: Fan runs or not relates with temperature during inverter stop mode, fan runs when inverter running. 2: Fan stop during inverter stop mode, running if not relates with temperature during inverter running	※	●	130H
E-49	Inverter protecting mode selection	<b>LED unit digit: Overvoltage protecting selection during deceleration</b> 0: Disable 1 Enable <b>LED ten digit: Output phase missing protection</b> 0: Disable 1 Enable <b>LED hundred digit: Input phase missing protection</b> 0: Disable 1 Enable <b>LED thousand digit: Inverter overload, over heat protect mode selection.</b> 0: Free stop 1: Running with current limit	0※11	●	131H
E-50	Coefficient value of electronic thermal	30%~120% (disable for value less than 30)	0%	●	132H
E-51	Stall protecting current limit value	100%~250%	160 G 120 P	●	133H
E-52	Stall protecting DC bus voltage threshold value	105~160%	138%	●	134H
E-53	Dynamic braking and decelerating over voltage suppression threshold voltage	105~160%	130%	●	135H
E-54	Ratio of dynamic braking	0~100%	100%	●	136H
E-55	DC bus under voltage protecting value	60~90%	65%	●	137H
E-56	Reserve				138H
E-57	Reserve				139H

E-58	Reserve				13AH
E-59	Rotation speed display scale factor	0.1~2000.0%	100.0%	●	13BH
E-60	Ratio of inverter output voltage	50~110%	100%	○	13CH
E-61	G/P type setting	0: type    1: type	0	○	13DH
E-62	Speed search stabilizing keeping time	0.200~10.000s	0.600s	●	13EH
E-63	Parameters change protection	0: All the parameters changing is allowed 1: Only keyboard digital given parameter changing allowed 2: All the parameters prohibit changing	0	●	13FH
E-64	Parameter initialization	0: Null 1: Restores to factory default setting value 2: Clear fault record 3: Transfer parameters of inverter to keypad and save. 4: Transfer parameters saved of keypad to inverter	0	○	140H
E-65	Factory password	0~9999	0	●	141H
E-66	Information inquiry	0: Null operation 1: State monitoring inquiry 2: Fault information inquiry	0	●	142H
E-67	Interference suppression selection	<b>LED unit digit: Overvoltage interference suppression</b> 0: Disable 1: Enable <b>LED ten digital: SC interference suppression</b> 0: Disable 1: SC interference suppression 1 2: SC interference suppression 2 <b>LED hundred digital: over current interference suppression</b> 0: Disable 1: Over current interference suppression 1 2: Over current interference suppression 2 <b>LED thousand digital: over current in deceleration suppression</b> 0: Disable 1: Enable 2: Enable frequency reducing for protecting over current.	0001	●	143H

### External terminal parameters

Code function	Function name	Setting range and define	Factory default	property	Communication code
F-01	Input signal selection 1 ( X1 )	0: Invalid 1: Forward jog operation 2: Reverse jog operation 3: Free stop 4: Fault reset	27	<input type="radio"/>	201H
F-02	Input signal selection2 ( X2 )	5: Multi steps speed control 1 6: Multi steps speed control 2 7: Multi steps speed control 3 8: Multi steps speed control 4 9: UP/Down running frequency increasing UP	28	<input type="radio"/>	202H
F-03	Input signal selection 3 ( X3 )	10:UP/Downrunning frequency decreasing DW 11: Three wire operation control D (X) 12: PID control cancel 13: External fault alarm	1	<input type="radio"/>	203H
F-04	Input signal selection 4 ( X4 )	14:Acceleration/deceleration time selection terminal 1. 15:Acceleration/deceleration time selection terminal 2 16: Frequency main channel selection terminal 1	2	<input type="radio"/>	204H
F-05	Input signal selection 5 (X5 )	17: Frequency main channel selection terminal 2 18: Frequency main channel selection terminal 3 19: Frequency main channel selection terminal 4	3	<input type="radio"/>	205H
F-06	Input signal selection 6 ( X6 )	20: Program running pause 21: Program restart 22: Timer trigger terminal 23: Timer reset terminal 24: Counter reset terminal 25:Counter clock input terminal 26:Only terminal control channel is enabled selection 27: Forward running 28: Reverse running	4	<input type="radio"/>	206H

F-07	Input signal respond mode selection	<p><b>LED unit digit: Free stop terminal recover mode</b>  0: Recover to original command with speed search function.  1: Don't recover to original command after free stop terminal disconnecting.  2: Recover to original command without speed search function.</p> <p><b>LED ten digit: UP and DW terminal control starting frequency setting</b>  0: Runs with UP/DW terminal adjusting without save the frequency record after power loss.  1: Run to last stop moment frequency and then perform UP/DW adjusting.  2: Runs to preset frequency [ F-70 ] first, and then execute UP/DW adjusting.</p> <p><b>LED hundred digit: STOP/RESE of keypad effective range selection.</b>  0: STOP/RESE key valid only when under keypad control  1: STOP/RESE key valid under any run command source</p> <p><b>LED thousand digit: Terminal running mode selection after fault reset</b>  0: Start inverter running directly after power on in terminal control mode  1: Stop first and then start in terminal control mode.</p>	0001	○	207H
F-08	Terminal running control mode	<p><b>LED unit digit: rminimal control mode selection</b>  0: Standard running control mode  1: 2wire running control mode  2: 2 wire control mode 1  3: 3 wire control mode 2  4: 3 wire control mode 3  5: 3 wire control mode 4</p> <p><b>LED ten digit: serve</b>  <b>LED hundred digit: serve</b>  <b>LED thousand: Reserve</b></p>	0000	○	208H
F-09	1 step speed setting 1X	0.00Hz~upper limit frequency	30.00Hz	●	209H
F-10	2 step speed setting 2X		25.00Hz	●	20AH
F-11	3 step speed setting 3X		40.00Hz	●	20BH
F-12	4 step speed setting 4X		50.00Hz	●	20CH

F-13	5 step speed setting 5X		50.00Hz	●	20DH
F-14	6 step speed setting 6X		40.00Hz	●	20EH
F-15	7 step speed setting 7X		25.00Hz	●	20FH
F-16	8 step speed setting 8X		10.00Hz	●	210H
F-17	Reserve				211H
F-18	Reserve				212H
F-19	Speed search tracking speed	0.1~10.0%	0.2%	○	213H
F-20	Voltage stores time	0.10S~10.00S	0.60S	○	214H
F-21	Speed search respond current threshold value	10%~200%	120%	○	215H
F-22	Frequency reducing acceleration time	0.1~6500.0s	2.0s	●	216H
F-23	Frequency reducing acceleration time	0.1~6500.0s	0.3s	●	217H
F-24	Acceleration time 2	0.1~6500.0s	※	●	218H
F-25	Deceleration time 2		※	●	219H
F-26	Acceleration time 3		※	●	21AH
F-27	Deceleration time 3		※	●	21BH
F-28	Acceleration time 4		※	●	21CH
F-29	Deceleration time 4		※	●	21DH
F-30	Relay output terminal (TA,TB,TC)	0: Zero frequency (standby state) 1: Fault alarm 1. (Including fault auto reset period.) 2: Fault alarm 2. (Not includes fault auto reset period.) 3: Frequency arriving detection	1	●	21EH
F-31	Output terminal Y1	4: Frequency level detection 5: Running statuses 6: Reverse running 7: Under voltage of inverter 8: Overload pre-alarm 9: Output frequency reach upper limit frequency 10. Output frequency reach lower limit frequency 11. External fault stop 12. Timer times up 13. Counter reach maximum values 14. Counter reach setting values 15. PID feedback upper limit alarm	4	●	21FH



F-32	Output terminal Y2	16. PID feedback lower limit alarm 17. Sensor broken 18. Program running cycle completed 19. Program running step completed 20. Dynamic braking processing 21. Output terminal control by external 22. Fault alarm 1. (Including fault auto reset period, including fault-LU1)	7	●	220H
F-33	Frequency arriving detect bias	0.00~50.00Hz	1.00Hz	●	221H
F-34	Output frequency level detection	0.00~600.0Hz	30.00Hz	●	222H
F-35	Output frequency level detecting relay time	0.0~20.0s	0.0s	●	223H
F-36	Overload pre-alarm level	50~200%	150%	●	224H
F-37	Overload pre-alarm delay time	0.0~20.0s	1.0s	●	225H
F-38	Timer setting value	1~65000s	1s	●	226H
F-39	Counter maximum value	1~65000	1000	●	227H
F-40	Counter setting value	1~ Counter maximum value	100	●	228H
F-41	VS1 terminal input voltage lower limit	0.00V~ [F-42]	0.50V	●	229H
F-42	VS1 terminal input voltage upper limit	[F-41] ~10.00V	9.50V	●	22AH
F-43	VS1 terminal input voltage gain	0.01~5.00	1.00	●	22BH
F-44	Reserve				22CH
F-45	Reserve				22DH
F-46	Reserve				22EH
F-47	Reserve				22FH
F-48	Reserve				230H
F-49	Reserve				231H
F-50	AS terminal input current lower limit	0.00mA~ [F-51]	4.20mA	●	232H
F-51	AS terminal input current upper limit	[F-50] ~20.0mA	19.50mA	●	233H
F-52	AS terminal input current gain	0.01~5.00	1.00	●	234H
F-53	Reserve				235H
F-54	Reserve				236H
F-55	Reserve				237H
F-56	Input lower limit correspond setting frequency	0.00Hz~ [F-57]	0.00Hz	●	238H
F-57	nput upper limit correspond setting frequency	[F-56] ~maximum frequency	50.00Hz	●	239H

F-58	Input signal characteristic selection	<b>LED unit digit: VS1 input characteristic selection</b> 0: Positive characteristic 1: Negative characteristic <b>LED ten digit: AS input characteristic selection</b> 0: Positive characteristic 1: Negative characteristic <b>LED hundred digit: VS2 input characteristic selection</b> 0: Positive characteristic 1: Negative characteristic <b>LED thousand digit: Pulse input characteristic selection</b> 0: Positive characteristic 1: Negative characteristic	0000	●	23AH
F-59	Terminal analog input filtering time constant	0.01 ~ 5.00	0.50	●	23BH
F-60	Reserve	0: Output signal disable 1: Output frequency/speed 2: Output current 3: Given frequency/speed reference		●	23CH
F-61	Output terminal ( AO2 ) selection	4: PID given value 5: PID feedback value 6: DC bus voltage 7: Output voltage	3	●	23DH
F-62	Analog output signal selection	<b>LED unit digit: A02 output signal mode selection</b> 0: Frequency pulse train output 1: 0 ~ 20mA 2: 4 ~ 20mA 3: 0 ~ 10V <b>LED ten digit: Reserve</b> <b>LED hundred digit: Reserve</b> <b>LED thousand digit: Reserve</b>	0003	●	23EH
F-63	Reserve			●	23FH
F-64	AO2 output signal gain	25% ~ 500%	100%	●	240H
F-65	Reserve			●	241H
F-66	AO2 output signal zero adjust	-10.0% ~ 10.0%	0.0%	●	242H
F-67	Keyboard potentiometer Input voltage lower limit	0.00V ~ [F-68]	0.20V	●	243H
F-68	Keyboard potentiometer Input voltage upper limit	[F-67] ~ 5.50V	4.80V	●	244H
F-69	Keyboard potentiometer gain	0.00 ~ 5.00	1.00	●	245H
F-70	UP/DW terminal preset frequency	0.00Hz ~ upper limit frequency	0.00Hz	●	246H
F-71	UP/DW Power-off memorized frequency	0.00Hz ~ upper limit frequency	0.00Hz	○	247H

### Special function parameters





Code function	Function name	Setting range and define	Factory default	property	Communication code
H-01	User setting voltage V1	0.0% ~ [H-03]	3.0%	○	301H
H-02	User setting frequency F1	0.0Hz~ [H-04]	1.00Hz	○	302H
H-03	User setting voltage V2	[H-01~H-05]	28.0%	○	303H
H-04	User setting frequency F2	[H-02~H-06]	10.00Hz	○	304H
H-05	User setting voltage V3	[H-03~H-07]	55.0%	○	305H
H-06	User setting frequency F3	[H-04~H-08]	25.00Hz	○	306H
H-07	User setting voltage V4	[H-05~H-09]	80.0%	○	307H
H-08	User setting frequency F4	[H-06~H-10]	37.50Hz	○	308H
H-09	User setting voltage V5	[H-07] ~100.0%	100.0%	○	309H
H-10	User setting frequency F5	[H-08] ~maximum frequency	50.00Hz	○	30AH
H-11	PID output characteristic	0: Positive characteristic 1: Negative characteristic	0	○	30BH
H-12	PID controller given signal sources	0: Keypad potentiometer 1: PID keypad digital given 2: External terminal VS1:0-10V 3: External terminal AS: 4~20mA 4: Reserve 5: Reserve 6: RS485 interface	1	○	30CH
H-13	PID controller feedback signal source	0: External terminal VS1:0-10V 1: External terminal AS: 4~20mA 2: Reserve 3: Reserve	1	○	30DH
H-14	PID preset frequency	0.00Hz~upper limit frequency	0.00Hz	○	30EH
H-15	PID preset frequency running time	0.0~6500.0s	0.0s	●	30FH
H-16	PID keypad digital given	0.0~100.0%	50.0%	●	310H
H-17	PID channel gain	0.01~5.00	1.00	●	311H
H-18	Sensor maximum measuring range	1.0~100.0	100.0	●	312H
H-19	Proportion gain P	0.1~100.0	20.0	●	313H
H-20	Integral time constant I	0.1~100.0s	2.0s	●	314H
H-21	Differential gain D	0.0~10.0	0.0	●	315H
H-22	Sampling period	0.01~60.00s	0.10s	●	316H
H-23	PID control deviation limit	0.0~20.0%	0.0%	●	317H
H-24	Starting threshold value	0.0%~Sleep threshold value	0.0%	●	318H
H-25	Sleep threshold value	Starting threshold value~100.0%	100.0%	●	319H

H-26	Alarm upper limit value	Alarm lower limit value~100.0%	100.0%	●	31AH
H-27	Alarm lower limit value	0.0%~Alarm upper limit value	0.0%	●	31BH
H-28	Sensor disconnection detection	0.0~20.0%	0.0%	●	31CH
H-29	Sensor disconnection alarm operation selection	0: continue running 1: Stop	0	●	31DH
H-30	Upper limit threshold	lower limit threshold~100.0%	100.0%	●	31EH
H-31	Lower limit threshold	0.0%~Upper limit threshold	0.0%	●	31FH
H-32	Program running mode	0: Single cycle running (time by second) 1: Continuous cycle running 2: single cycle, continuous running (time by second) 3: Single cycle running (time by minute) 4: Continuous cycle (time by minute) 5: Single cycle, continuous running (time by minute)	0	○	320H
H-33	Program run breakpoint restore mode selection	0: Running at the first step speed 1: Continue to run with breakpoint running frequency and retiming. 2: Continue to run with the breakpoint running frequency and residual time.	0	○	321H
H-34	Program running state power down memory selection	0: NO power down memory 1: power down memory	0	○	322H
H-35	1 step speed direction and accel/decel time	0: Forward; Acceleration time 1/Deceleration time 1	0	●	323H
H-36	2 step speed direction and accel/decel time	1: Forward; Acceleration time 1/Deceleration time 2	1	●	324H
H-37	3 step speed direction and accel/decel time	2: Forward; Acceleration time 1/Deceleration time 3	2	●	325H
H-38	4 step speed direction and accel/decel time	3: Forward; Acceleration time 1/Deceleration time 4	3	●	326H
H-39	5 step speed direction and accel/decel time	4: Reverse; Acceleration time 1/Deceleration time 1	4	●	327H
H-40	6 step speed direction and accel/decel time	5: Reverse; Acceleration time 1/Deceleration time 2	5	●	328H
H-41	7 step speed direction and accel/decel time	6: Reverse; Acceleration time 1/Deceleration time 3	6	●	329H
H-42	8 step speed direction and accel/decel time	7: Reverse; Acceleration time 1/Deceleration time 4	7	●	32AH
H-43	1 step speed running time T1	0.0~6000s(min)	10.0	●	32BH
H-44	2 step speed running time T2		10.0	●	32CH
H-45	3 step speed running time T3		10.0	●	32DH
H-46	4 step speed running time T4		10.0	●	32EH
H-47	5 step speed running time T5		10.0	●	32FH
H-48	6 step speed running time T6		10.0	●	330H
H-49	7 step speed running time T7		10.0	●	331H

H-50	8 step speed running time T8		10.0	●	332H
H-51	Differential frequency $\Delta f$ in swing frequency	0.00~20.00Hz	2.00Hz	●	333H
H-52	Motor rated power	0.4~1100.0KW	※	○	334H
H-53	Motor rated frequency	0.00~600.00Hz	50.00Hz	○	335H
H-54	Motor rated speed	0~18000RPM	※	○	336H
H-55	Motor rated voltage	0~1500V	※	○	337H
H-56	Motor rated current	0.1~1000.0A	※	○	338H
H-57	Motor no load current	0.01~650.00A	※	○	339H
H-58	Motor stator resistor	0.001~65.000Ω	※	○	33AH
H-59	Motor rotator resistor	0.001~65.000Ω	※	●	33BH
H-60	Motor stator inductance	0.1~6500.0mH	※	●	33CH
H-61	Motor rotator mutual inductance	0.1~6500.0mH	※	●	33DH
H-62	Motor auto tuning selection	0: Null operation. 1: Rotational motor auto tuning. 2: Stationary auto tuning	0	○	33EH
H-63	Motor magnetic saturation coefficient 1	0~9999	※	●	33FH
H-64	Motor magnetic saturation coefficient 2	0~9999	※	●	340H
H-65	Motor magnetic saturation coefficient 3	0~9999	※	●	341H
H-66	Linkage main station setting	0: Local machine configure as linkage slave station 1: Main station control mode 1. 2: Main station control mode 2.	0	●	342H
H-67	Local inverter address	1~247	1	●	343H
H-68	Data format	0: No check (N,8,1) 1: Even parity check (E,8,1) 2: Odd parity check (O,8,1) 3: No check (N,8,2)	3	○	344H
H-69	Baud rate	0: 1200bps 1: 2400bps 2: 4800bps 3: 9600bps 4: 19200bps 5: 38400bps	3	○	345H
H-70	Communication setting frequency ratio	0.00~20.00	1.00	●	346H
H-71	Time of communication time out	0.0~6500.0s	10.0s	●	347H





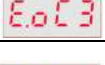





H-72	RS485 communication broken responding mode	<b>LED“0” digit: RS485 communication broken responding mode</b> 0.Give alarm and free stop 1.No alarm and continue running 2.No alarm but stop <b>LED “00” digit: Communicaitaion write operation mode.</b> 0: Reply for write opertaion 1: Noreply for write operation <b>LED “000” digit:: Reserve</b> <b>LED “0000” digit: Reserve</b>	0001	●	348H
H-73	Respond relay	0.000~1.000s	0.005s	●	349H
H-74	Instantaneous stop decel. respond voltage lower limit	0%~200%	20%	●	34AH
H-75	Instantaneous stop decel. respond voltage upper limit	0%~200%	90%	●	34BH
H-76	Instantaneous stop decel. gain	0.01~10.00	2.00	●	34CH
H-77	Voltage recover stability time	0.0~100.0s	2.0s	●	34DH
H-78	Torque compensation upper limit	0.00~60.00%	50.00%		34EH
H-79	Output terminal external control status	0~9999	0	●	34FH
H-80	Reserve				350H

# Chapter 5: Fault Information and Troubleshooting

Keyboard display	Fault code	Fault type	Possible causes	Treatment
	L.U.1	Too low voltage while stop	<ul style="list-style-type: none"> <li>● Power supply is too low</li> <li>● Voltage detection circuit is abnormal</li> </ul>	<ul style="list-style-type: none"> <li>● Check input power,clear fault.</li> <li>● Seek support from factory.</li> </ul>
	E.LU2	Too low voltage in run	<ul style="list-style-type: none"> <li>● Power supply is too low</li> <li>● Power capacitance is too small, or there is big impact current in the power grid.</li> <li>● Inner DC main contactor is not connect well</li> </ul>	<ul style="list-style-type: none"> <li>● Check input power,clear fault.</li> <li>● Improve power supply.</li> <li>● Seek support from factory.</li> </ul>
	E.oU1	Accel. over-voltage	<ul style="list-style-type: none"> <li>● Power voltage fluctuation over limit.</li> <li>● Start when motor is running .</li> </ul>	<ul style="list-style-type: none"> <li>● Detect power voltage and clear fault.</li> <li>● Restart motor until it completely stop,Set F1.00 as 1or2.</li> </ul>
	E.oU2	Decel. over-voltage	<ul style="list-style-type: none"> <li>● Deceleration time is too short.</li> <li>● Load potential energy or inertia is too large.</li> <li>● Power voltage fluctuation over limit.</li> </ul>	<ul style="list-style-type: none"> <li>● Prolong Deceleration time.</li> <li>● Reduce load inertia or improve inverter capacitance or add braking unit.</li> <li>● Detect power voltage and clear fault.</li> </ul>
	E.oU3	Constant speedover-voltage	<ul style="list-style-type: none"> <li>● Power voltage fluctuation over limit.</li> </ul>	<ul style="list-style-type: none"> <li>● Detect power voltage and clear fault.</li> <li>● Install input reactor.</li> </ul>
	E.oC1	Accel. over-current	<ul style="list-style-type: none"> <li>● Acceleration time is too short.</li> <li>● Start running motor.</li> <li>● V/F curve setting is not suitable.Or torque boost too high.</li> <li>● Inverter capacitance is too small.</li> </ul>	<ul style="list-style-type: none"> <li>● Prolong acc time.</li> <li>● Restart motor until it totally stop,Set F1.00 as 1or2.</li> <li>● Reset V/F curve or torque boost value.</li> <li>● Select inverter with right capacitance.</li> </ul>
	E.oC2	Decel. over-current	<ul style="list-style-type: none"> <li>● Deceleration time is too short.</li> <li>● Load potential energy or inertia is too large.</li> <li>● Power voltage fluctuation over limit.</li> </ul>	<ul style="list-style-type: none"> <li>● Prolong Deceleration time.</li> <li>● Connect external braking resistance or braking unit.</li> <li>● Select inverter with right capacitance.</li> </ul>
	E.oC3	Constant speedover-current	<ul style="list-style-type: none"> <li>● Sudden load change.</li> <li>● Power grid voltage is too low.</li> </ul>	<ul style="list-style-type: none"> <li>● Check load change and clear it.</li> <li>● Check input power,clear fault.</li> </ul>
	E.oL1	Motor over-load	<ul style="list-style-type: none"> <li>● V/F curve setting is not suitable. Or torque boost too high.</li> <li>● Power grid voltage is too low.</li> </ul>	<ul style="list-style-type: none"> <li>● Reset V/F curve or torque boost value.</li> <li>● Check input power,clear fault.</li> </ul>

			<ul style="list-style-type: none"> <li>● incorrect overload protection setting.</li> <li>● Locked-rotor run or too heavy load.</li> <li>● Universal motor long time low speed run.</li> </ul>	<ul style="list-style-type: none"> <li>● Unreasonable F5.06 setting.</li> <li>● Adjust load or select inverter with right capacitance.</li> <li>● If need long time low speed run, please choose special motor for inverter.</li> </ul>
E.oL2	E.oL2	Inverter over-load	<ul style="list-style-type: none"> <li>● Load is too heavy.</li> <li>● Acceleration time is too short.</li> <li>● Start running motor.</li> <li>● V/F curve setting is not suitable. Or torque boost too high.</li> </ul>	<ul style="list-style-type: none"> <li>● Select inverter with right capacitance.</li> <li>● Prolong acceleration time</li> <li>● Restart motor until it totally stop. Set F1.00 as 1or2.</li> <li>● Reset V/F curve or torque boost value.</li> </ul>
E. SC	E. SC	System abnormality	<ul style="list-style-type: none"> <li>● Acceleration time is too short.</li> <li>● Short circuit between inverter output phases or earth.</li> <li>● Module is damaged.</li> <li>● Electromagnetic disturb.</li> </ul>	<ul style="list-style-type: none"> <li>● Prolong acceleration time.</li> <li>● Check periphery equipments and restart after fault cleared.</li> <li>● Seek support from factory.</li> <li>● Check system wiring, earth, shield and deal as required.</li> </ul>
E.oH	E.oH	Inverter over-heat	<ul style="list-style-type: none"> <li>● Temperature is too high.</li> <li>● Air channel is blocked.</li> <li>● Fan connection parts is loose.</li> <li>● Fan is damaged.</li> <li>● Temperature detection circuit fault</li> </ul>	<ul style="list-style-type: none"> <li>● Make the environment meeting the requirement.</li> <li>● Clear the air channel.</li> <li>● Check and re-connect the wire</li> <li>● Change the same new fan.</li> <li>● Seek support from factory.</li> </ul>
E.TE1	E.TE1	Motor static detection fault	<ul style="list-style-type: none"> <li>● Detection overtime</li> <li>● Perform static detection while motor is running.</li> <li>● Capacitance difference is too big between motor and inverter.</li> <li>● Motor parameter setting mistake.</li> </ul>	<ul style="list-style-type: none"> <li>● Check motor connection wire.</li> <li>● Detect after motor stop totally.</li> <li>● Change inverter model.</li> <li>● Reset parameter according to nameplate.</li> </ul>
E.TE2	E.TE2	Moror rotation detection fault	<ul style="list-style-type: none"> <li>● Detect while motor is running.</li> <li>● Detect with load.</li> <li>● Detection overtime</li> <li>● Capacitance difference is too big between motor and inverter.</li> <li>● Motor parameter setting mistake.</li> </ul>	<ul style="list-style-type: none"> <li>● Detect after motor stop totally.</li> <li>● Re-detect without load.</li> <li>● Check motor connection wire.</li> <li>● Change inverter model.</li> <li>● Reset parameter according to nameplate.</li> </ul>
93SE	93SE	Memory fault	<ul style="list-style-type: none"> <li>● Electromagnetic disturb in memory period.</li> <li>● EEPROM damage.</li> </ul>	<ul style="list-style-type: none"> <li>● re-input and save.</li> <li>● Seek support from factory.</li> </ul>
L.IFE	LIFE	Reserved		<ul style="list-style-type: none"> <li>● Seek support from factory.</li> </ul>



	ERR2	Output phase missing	<ul style="list-style-type: none"> <li>● 3 phase output of inverter missing connection with motor</li> </ul>	<ul style="list-style-type: none"> <li>● Check wire between inverter and motor, earth and motor insulation.</li> </ul>
	ERR3	Current detection fault	<ul style="list-style-type: none"> <li>● Detect circuit fault.</li> <li>● Phase imbalance</li> </ul>	<ul style="list-style-type: none"> <li>● Seek for technic support.</li> <li>● Check motor and wiring.</li> </ul>
	ERR4	Inverter external fault	<ul style="list-style-type: none"> <li>● Peripheral equipment fault protection.</li> </ul>	<ul style="list-style-type: none"> <li>● Check peripheral equipment.</li> </ul>
	ERR5	Swing frequency fault	<ul style="list-style-type: none"> <li>● User not set right swing frequency running parameter.</li> </ul>	<ul style="list-style-type: none"> <li>● Set parameter again.</li> </ul>
	ERR6	Keyboard connect fault	<ul style="list-style-type: none"> <li>● Keyboard wire fault.</li> <li>● Keyboard component damage.</li> </ul>	<ul style="list-style-type: none"> <li>● Check keyboard wire</li> <li>● Seek support from factory.</li> </ul>
	E.CPE	Parameter copy fault	<ul style="list-style-type: none"> <li>● Parameter copy communication is fault.</li> <li>● Copy keyboard is not match the inverter.</li> </ul>	<ul style="list-style-type: none"> <li>● Check wire.</li> <li>● Select the specified external keyboard model.</li> </ul>
	E.CE	RS485 communication fault	<ul style="list-style-type: none"> <li>● Paut rate not right.</li> <li>● Communication connection not right.</li> <li>● Communication format not right.</li> </ul>	<ul style="list-style-type: none"> <li>● Set right Paut rate</li> <li>● Check communication wiring</li> <li>● Check Communication format</li> </ul>
	SEn	Feedback sensor fault	<ul style="list-style-type: none"> <li>● Alarm while PID analog value feedback signal is small than [H-28].</li> <li>● PID feedback wire problem.</li> <li>● Feedback sensor problem.</li> <li>● Feedback input circuit problem.</li> </ul>	<ul style="list-style-type: none"> <li>● Confirm sensor state,change it if problem</li> <li>● Check wiring.</li> <li>● Adjust feedback channel signal</li> </ul>
	E.PAn	Keyboard connect fault	<ul style="list-style-type: none"> <li>● Keyboard wire fault.</li> <li>● Keyboard component damage.</li> </ul>	<ul style="list-style-type: none"> <li>● Check keyboard wire</li> <li>● Seek support from factory.</li> </ul>
	E.EF	Inverter external fault	<ul style="list-style-type: none"> <li>● Peripheral equipment fault protection.</li> </ul>	<ul style="list-style-type: none"> <li>● Check peripheral equipment.</li> </ul>
	E.PAn	Keyboard connect fault	<ul style="list-style-type: none"> <li>● Keyboard wire fault.</li> <li>● Keyboard component damage.</li> </ul>	<ul style="list-style-type: none"> <li>● Check keyboard wire</li> <li>● Seek support from factory.</li> </ul>

## Chapter 6: Overhaul and Maintenance

During frequency inverter normal operation, except for daily inspections, periodic (such as machine overhaul or inspections at least every six months as required) inspections must be performed according to the following table, to prevent trouble before it happens.

Inspection period	Inspection part	Inspection items	Inspection content	Inspection methods	Criteria
At any time	Display	LED display	If display is abnormal or not	Vision	No abnormal
At any time	Cooling system	Fan	If there is abnormal vibration or abnormal noise.	Visual examination and listening	No abnormal
At any time	Environment	Surrounding environment	Temperature, humidity, dust, harmful gas	Visual examination smelling, feeling	By 2-1 term
At any time	Input terminal	Voltage	If input, output voltage is abnormal	Detect R,S,T and U,V,W terminal	according to the standards regulation
periodic	Main circuit	panorama	If the fastener loosen , whether having the hot shot trail , whether having discharging or not phenomenon , dust are too much, if the wind way is blocked up	Visual, tighten, clean	No abnormal
		Electrolytic capacitor	If surface is abnormal	Visual	No abnormal
		Wire conductive bar	Whether loosen	Visual	No abnormal
		Terminal	Whether the bolt or screw loosen	tighten	No abnormal

During the examination, not allowed to dismantle or rock a component for no reason, even pull off a connector assembly. Otherwise, it can not run or enter malfunction display state. And it will bring faults of the component, even damage the host switch component IGBT module. When needing measurement, user should pay attention to various different meters which may reach very different measurement results. Pointer voltmeter is recommended to use to measure input voltage. Rectifier voltmeter is recommended to use to measure output voltage. Pliers galvanometer is recommended to use to measure input and output current. And electro-dynamics wattmeter is recommended to use to measure power.

If the frequency inverter is not in use immediately after purchased, and need to be temporarily stored or long-term stored up, pls obey belowing rules:

1 Frequency inverter should be stored in the place with standard temperature range, fine ventilation and no humidity, dust or metal dust.

2 If frequency inverter has not been put into use yet for more than 1 year, user should carry on charging testing to restore the characteristic of the inner main circuit filter capacitor. During charging, user can use the pressure regulator to elevate slowly the input voltage of the frequency inverter to the rated input voltage. The charging time should be above 1-2 hours. At least test once every year as narrated above.

3 Frequency inverters are not allowed to be carried out the pressure testing, otherwise, it will lead to frequency inverter life lessening or damage. Before the insulation testing, user should use 500 M $\Omega$ volt megger measures the frequency inverter. Its insulation resistance should not smaller than 4M $\Omega$ . When using the general ohmmeters to measure current, the current in the input end will has imbalance phenomenon. Generally the difference within 50% is regular. If using general multimeter to measure the output three-phase voltage, due to being limited by the carry wave frequency disturbance and multimeter frequency response, the read data, which maybe inaccurate, can be for reference only. In order to guarantee the frequency inverter stable operation, except for periodic maintenance, the inner component which bears long-term mechanical wear should be periodic replaced—including the cooling fan, main circuit filter capacitor for energy caching and exchange, printed circuit board. In general continuous using, users can replace them according to below regulation. Also should according to the concrete conditions such as the usage environment, load condition and frequency inverter current situation.

Component name	Replace year criteria
Cooling fan	2—3 year
Filter capacitor	4—5 year
printed circuit board	8—10 year

## Chapter 7: Quality Guarantee

This product quality guarantee is processed as the follows items:

**Users can enjoy the following “three guarantee” service from the day of buying products if meeting products quality problem:**

- 1 We guarantee for repair, return and replacement for one month after delivery;
- 2 We guarantee for repair and replacement for two months after delivery;
- 3 We guarantee for repair for three months after delivery;
- 4 When product is exported to abroad, we guarantee for repair for three months after reaching customer.

**No matter where you purchase products, you can enjoy lifelong paid service.**

**The agency, dealer, provider can provide “three guarantee” service after being authorized by our company.**

**When quality problem appears, our company only undertakes “three guarantee” service as the 11.1 and 11.2 responsibilities above. If user needs more responsibility guarantee, please insure the product by cooperation with the insurance company.**

**The malfunctions, caused by the reasons mentioned as below, can only enjoy the paid service even if the product under warranty,**

- 1 The malfunctions caused by misoperations which are not in compliance with this user manual;
- 2 The malfunctions caused by unauthorized transform or over-range operation.
- 3 User has not paid off the payment according to the contract;
- 4 The malfunctions caused by the earthquake, fire, flood, lightning, or abnormal voltage, etc;

**As for the “three guarantee” service, the product must be returned back to our company and can only be replaced or mend after responsibility belonging confirmed.**

# Appendix

## 1. Monitor inquiry

Select this function to enter monitoring menu (group C parameters), and inquire each state parameters of the frequency inverter. In the monitoring state, you can long press (1 second) PRG key and directly enter the state of the group C parameters which namely is the state monitoring.

Monitoring code	Content	Units	Communication code
C-1	Given frequency	0.01HZ	C01H
C-2	Output frequency	0.01HZ	C02H
C-3	Output current	0.1A	C03H
C-4	Input voltage	V	C04H
C-5	Output voltage	V	C05H
C-6	Mechanical speed	RPM	C06H
C-7	PID given quantitative	%	C07H
C-8	PID feedback quantitative	%	C08H
C-9	Module temperature	°C	C09H
C-10	Accumulative operation time	hour	C0AH
C-11	Accumulative operation time after latest power on	Min	C0BH
C-12	Output current percentage	%	C0CH
C-13	Step operation remainder time percentage	%	C0DH
C-14	Input terminals connect/disconnect status	See belowing diagram	C0EH
C-15	Input terminals connect/disconnect status	See belowing diagram	C0FH
C-16	Terminal VS1 input value	0.1v	C10H
C-17	Terminal AS input value	0.1mA	C11H
C-18	Terminal VS2 input value	0.1v	C12H
C-19	Terminal pulse input value	※	C13H
C-20	Counter record	※	C14H
C-21	DC bus voltage	V	C15H
C-22	Analog output A01	0.01V	C16H
C-23	Frequency/voltage/current output A02	※	C17H
C-24	Reserved	-	C18H
C-25	Inverter power grade	Kw	C19H

C-26	Inverter rated voltage	V	C1AH
C-27	Inverter rated current	0.1A	C1BH
C-28	Software version	※	C1CH

Input terminal connect/disconnect state schematic diagram

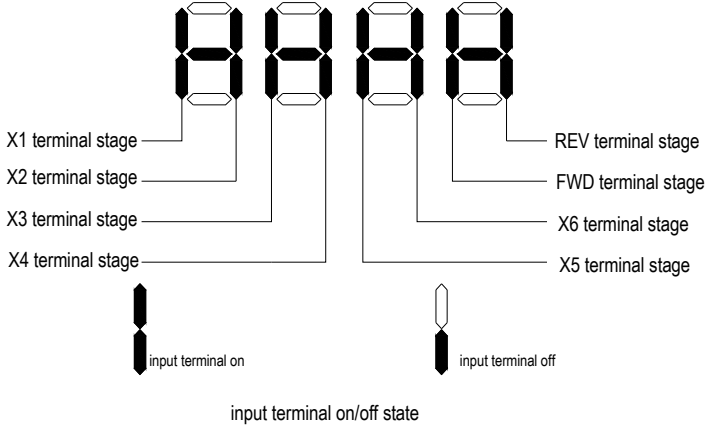

Output terminal connect/disconnect state schematic diagram

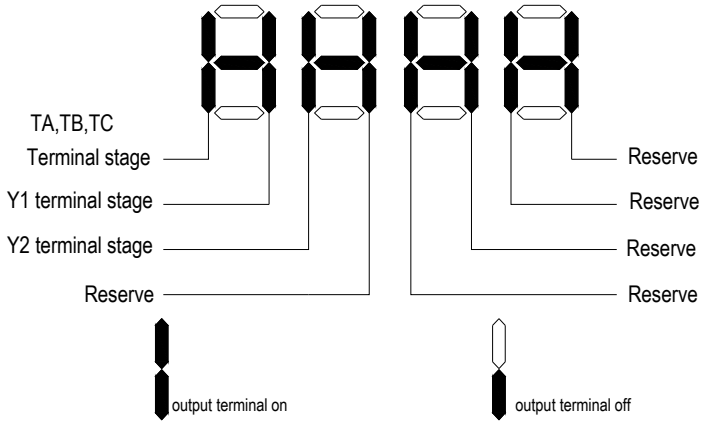

## 2. Fault information inquiry

After inquiry setting, can set LED display below information circularly by the keyboard **up/down** keys.

Serial number	Definition	Remark	Communication code
Er.01	The latest fault information	For details, pls see fault information code table	E01H
Er.02	The cumulative running time before the latest fault	Units: hour	E02H
Er.03	Output frequency while the latest fault	Units: Hz	E03H
Er.04	DC bus voltage while the latest fault	Units: V	E04H
Er.05	Output current while the latest fault	Units: A	E05H
Er.06	Output voltage while the latest fault	Units: V	E06H
Er.07	Module temperature while the latest fault	Units: °C	E07H
Er.08	Running direction while the latest fault	0.Forward 1.reverse	E08H
Er.09	Running status while the latest fault	0.close down 1.stable speed 2.acceleration 3.deceleration	E09H
Er.10	Protection status while the latest fault	0. Normal 1.only voltage amplitude limit 2. only current amplitude limit 3.both voltage and current amplitude limit	E0AH
Er.11	Input terminal status while the latest fault	See above chart	E0BH
Er.12	Output terminal status while the latest fault	See above chart	E0CH
Er.13	The latest one fault information		E0DH
Er.14	The latest two fault information		E0EH
Er.15	The latest three fault Information		E0FH

## Warranty Card

### Profile

User Name : \_\_\_\_\_

Address : \_\_\_\_\_

Contacts : \_\_\_\_\_ Phone : \_\_\_\_\_ Fax : \_\_\_\_\_

Model : \_\_\_\_\_ Machine Code : \_\_\_\_\_

### Agent/Distributor Profile

Delivery Company : \_\_\_\_\_

Contacts : \_\_\_\_\_ Phone : \_\_\_\_\_ Delivery Date : \_\_\_\_\_

## Warranty Clauses

The Company solemnly states that since the day users purchase from my company (hereinafter referred to as manufacturer), they can enjoy the following warranty services:

1. Since the date of purchase, users can enjoy the following warranty services of the product:
  - 1) Within 30 days after shipment, the company promises returning, replacement and maintenance of the product.
  - 2) Within 90 days after shipment, the company promises replacement and maintenance of the product.
  - 3) Within 18 months after shipment, the company promises only maintenance of the product.
  - 4) Products exported to countries except China shall not enjoy the warranties mentioned above.

2. Since the date of purchase, users can enjoy the service of the company when they pay for the service.

3. Exception Clauses: Product failures caused by the following reasons would not enjoy the free warranty services of the manufacturer:

- 1) Failures caused by operations of users that is not operated in accordance with the requirements of the product manual;
- 2) Failures caused when users repair or renovate the product without communicating with the manufacturer in advance;
- 3) Failures caused by abnormal aging of the product resulted from poor using environment;
- 4) Failures caused by earthquake, fire or other natural disasters or abnormal voltage;
- 5) Failures caused by damage during transportation (mode of transportation is decided by users and the company only helps to handle cargo shipment procedures).

4. In the following conditions, the manufacturer have the right not to provide warranty services:

- 1) When the marks, trademarks or nameplates of the products are destroyed or can not be identified;
- 2) When users do not pay for the product according to signed contract;
- 3) When users intentionally hiding the improper operations during installation, wiring and maintenance;

5. For products that enjoy all returning, replacement and maintenance services, first the product should be returned to the company and after responsibility confirmation, the product can be replaced or repaired.

## Certificate of Approval

QC check :



The product has been checked and proved to be qualified for delivery in conformity with standard.