

VC-4PT Resistive Temperature Input Module User Manual

Thank you for purchasing the vc-4pt resistance temperature input module developed and produced by Suzhou VEICHI Electric Technology Co., Ltd. Before using our VC series PLC products, please read this manual carefully, so as to better grasp the characteristics of the products and correctly install and use them. More secure application and make full use of the rich functions of this product.

Tip:

Please read the operating instructions, precautions and cautions carefully before starting to use the product in order to reduce the risk of accidents. Personnel responsible for the installation and operation of the product must be strictly trained to comply with the safety codes of the relevant industry, strictly observe the relevant equipment precautions and special safety instructions provided in this manual, and carry out all operations of the equipment in accordance with the correct operating methods.

1 Interface description

1.1 Interface description

The expansion interface and user terminals of the VC-4PT are covered with flaps, and the expansion interface and user terminals are exposed when each flap is opened. The appearance and interface terminals are shown in Figure 1-1.

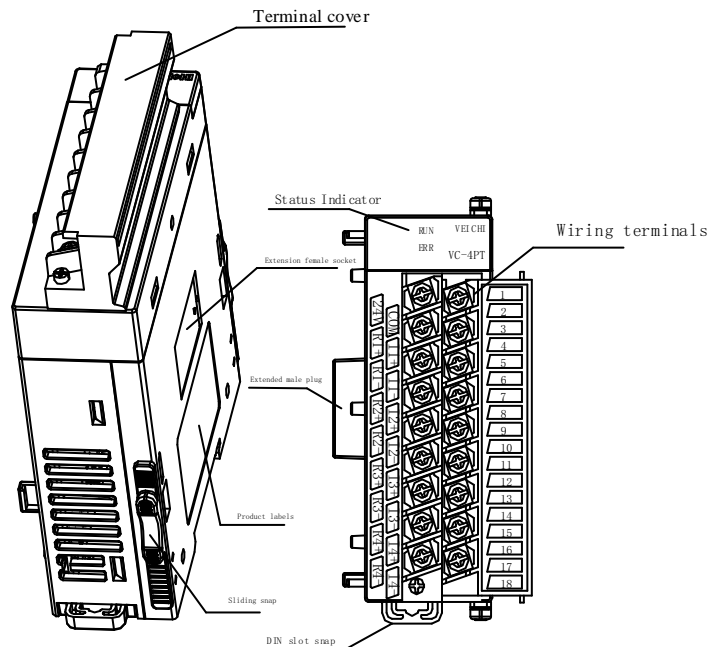

Figure 1-1 Module interface appearance - Module interface terminal diagram

1.2 Product

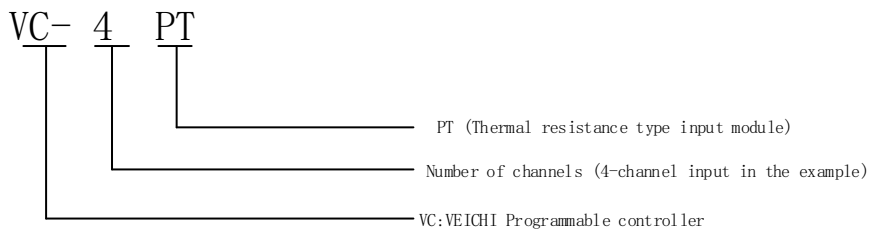

Figure 1-2 Model number

The VC-4PT is connected to the system via the expansion interface, which is used for the connection of other expansion modules of the system, as described in 1.4 Accessing the system

1.3 Definition of terminal

The user terminals are shown in Figure 1-3

No.	Marking	Instruction	No.	Marking	Instruction
1	24V	Analogue power supply 24V positive	2	COM	Analogue power supply 24V negative
3	R1+	Positive input for channel 1 RTD signal	4	I1+	Channel 1 RTD signal auxiliary positive input
5	R1-	Channel 1 RTD signal negative input	6	I1-	Auxiliary negative input for channel 1 RTD signal
7	R2+	Positive input for channel 2 RTD signal	8	I2+	2nd channel RTD signal auxiliary positive input
9	R2-	Positive input for channel 2 RTD signal	10	I2-	Channel 2 RTD signal auxiliary negative input
11	R3+	Positive input for channel 3 RTD signal	12	I3+	3rd channel RTD signal auxiliary positive input
13	R3-	Channel 3 RTD signal negative input	14	I3-	3rd channel RTD signal auxiliary negative input
15	R4+	Positive input for channel 4 RTD signal	16	I4+	Channel 4 RTD signal auxiliary positive input
17	R4-	Positive input for channel 4 RTD signal	18	I4-	Channel 4 RTD signal auxiliary negative input

Figure 1-3 Terminal definition table

1.4 Access system

The expansion interface allows the VC-4PT to be connected to a main module of the VC series PLC or to other expansion modules. The expansion interface can also be used to connect other expansion modules of the same or different models of the VC series. This is shown in Figure 1-4.

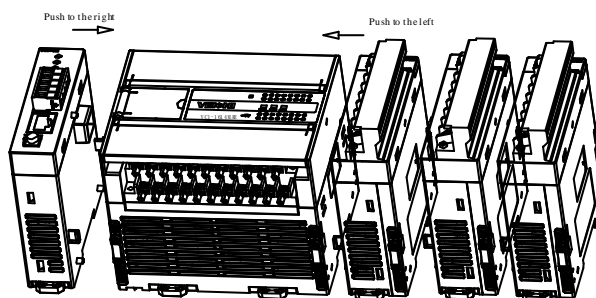

Figure 1-4 Schematic diagram of the connection to the main module and other expansion modules

1.5 Wiring instruction

User terminal wiring requirements, as shown in Figure

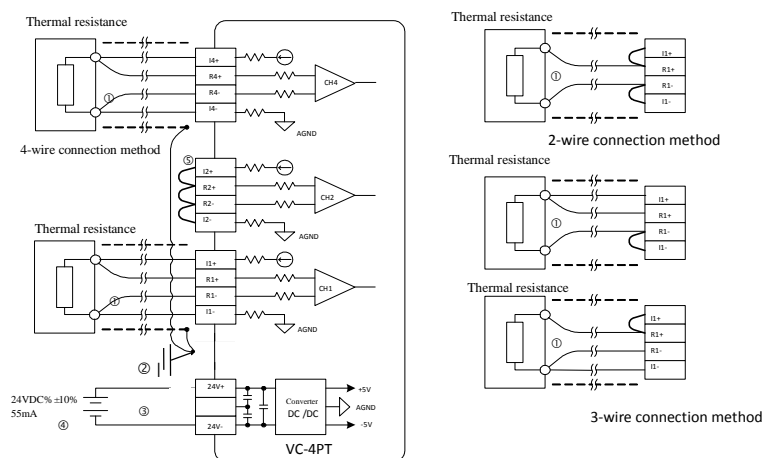

Figure 1-5 Diagram of user terminal wiring

The diagrams ① - ⑤ indicate the five aspects that must be taken into account when wiring.

1. The RTD signal is connected via a shielded cable. The cable should be routed away from power cables or other wires that may cause electrical interference. The cables to be connected to the RTD are described as follows.

1) RTD sensors (type Pt100, Cu100, Cu50) can be connected using 2, 3 or 4-wire system, with 4-wire system connection being the most accurate, 3-wire system the second most accurate and 2-wire system the worst. When the wire length is greater than 10m, it is recommended to use 4-wire connection to eliminate the wire resistance error.

2) In order to reduce the measurement error, and to avoid interference by noise, it is recommended to use a length of less than 100m connection cable. The measurement error is caused by the impedance of the connection cable and may be inconsistent for different channels in the same module, so it is necessary to adjust the characteristics of each channel, as described in 3 Characteristics setting. 2.

2. If there is excessive electrical interference, connect the shield ground terminal.

3. Connect the external power supply PE to a good earth.

4. The analogue power supply can be supplied from the 24 Vdc output of the main module or from another source that meets the requirements.

5. Short the positive and negative terminals of the channel not in use to prevent false data being detected on this channel.

2 Instruction for use

2.1 Power indicator

Table 2-1 Power supply indicators

Project	Indicator
Analog circuits	24Vdc (-10 % to +10 %) Maximum allowable ripple voltage 2 % 50mA (from mains module or external power supply)
Digital Circuit	5Vdc, 70mA (from the main module)

2.2 Performance indicators

Table 2-2 Performance indicators

Project	Indicator			
	Celsius (°C)		Fahrenheit (°F)	
Input signal	RTD type: Pt100, Cu100, Cu50 Number of channels: 4			
Conversion speed	(15 ±2%) ms ×4 channels (unused channels are not converted)			
Rated temperature range	Pt100	-150°C ~ +600°C	Pt100	-238 °F ~ +1112 °F
	Cu100	-30°C ~ +120°C	Cu100	-22 °F ~ +248 °F
	Cu50	-30°C ~ +120°C	Cu50	-22 °F ~ +248 °F
Digital output	12-bit A/D conversion; temperature values stored in 16-bit binary complement			
	Pt100	-1500 ~ +6000	Pt100	-2380 ~ +11120
	Cu100	-300 ~ +1200	Cu100	-220 ~ +2480
	Cu50	-300 ~ +1200	Cu50	-220 ~ +2480
Minimum resolution	Pt100	0.2°C	Pt100	0.36 °F
	Cu100	0.2°C	Cu100	0.36 °F
	Cu50	0.2°C	Cu50	0.36 °F
Precision	±0.5% of full scale			
Isolation	The analogue circuitry is isolated from the digital circuitry by an opto-coupler. The analogue circuitry is internally isolated from the module input 24Vdc supply. No isolation between analogue channels			

2.3 Indicator light description

Project	Instruction
Signal indicator	RUN status indicator, blinking when normal ERR error status indicator, illuminated on failure
Expansion module rear stage interface	Connection of rear modules, hot-swappable not supported
Expansion module front interface	Connection of front-end modules, hot-swappable not supported

3 Characteristic setting

(1) The input channel characteristics of the VC-4PT are a linear relationship between the channel analogue input temperature A and the channel digital output D, which can be set by the user. Each channel can be interpreted as the model shown in Figure 3-1. As it is linear, the channel characteristics can be determined by determining two points P0 (A0, D0) and P1 (A1, D1). Where

D0 indicates that the channel outputs digital when the analogue input is A0 and D1 indicates that the channel outputs digital when the analogue input is A1

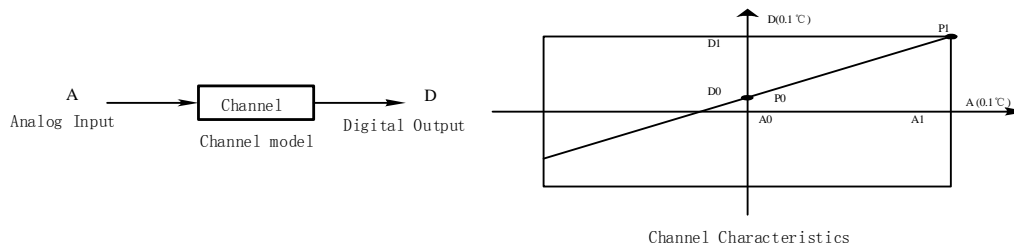
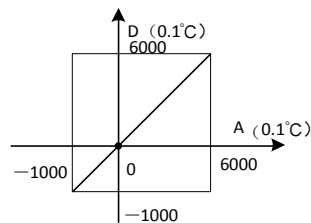

Figure 3-1 Schematic diagram of VC-4PT channel characteristics

(2) The measurement error is caused by the impedance of the connection cable, which can be eliminated by setting the channel characteristics.

(3) Considering the user's ease of use and without affecting the function, in the current mode, A0 and A1 are corresponding to [Actual Value 1] and [Actual Value 2] respectively, and D0 and D1 are corresponding to [Standard Value 1] and [Standard Value 2] respectively, as shown in Figure 3-1, the user can change the channel characteristics by adjusting (A0,D0) and (A1,D1), the factory default (A0,D0) As shown in Figure 3-2, A0 is 0, A1 is 6000 (unit is 0.1°C)



Factory setting (no adjustment)

Figure 3-2 Channel characteristics for each mode without changing the D0 and D1 values of each channel

(4) If the VC-4PT measurement value is 5 °C (41 °F) higher in actual use, the error can be eliminated by setting the two points P0 (0, -50) and P1 (6000, 5950) of the characteristic adjustment, see Figure 3-3 for an example.

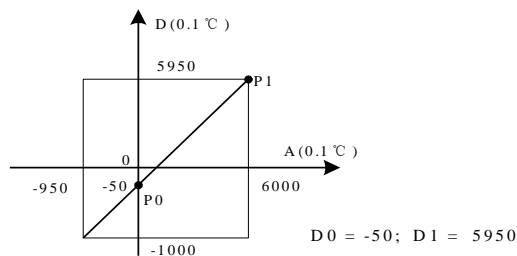

Figure 3-3 Example of characteristic change

4 Programming example

4.1 Programming example for VC series + VC-4PT module

As shown in the example below, the VC-4PT is connected to position 1 of the expansion module and uses channel 1 to connect to a Pt100 RTD to output Celsius temperature, channel 2 to connect to a Cu100 RTD to output Celsius temperature and channel 3 to connect to a Cu50 RTD to output Fahrenheit temperature, with channel 4 switched off and the number of average points set to 8 and the data registers D0, D1 and D2 to receive the The average value conversion result. The settings are shown in Figure 4-1 to Figure 4-3. See the VC Series Programmable Controllers Programming Reference Manual for further details.

- 1) Create a new project and configure the hardware for the project as shown in the figure below.

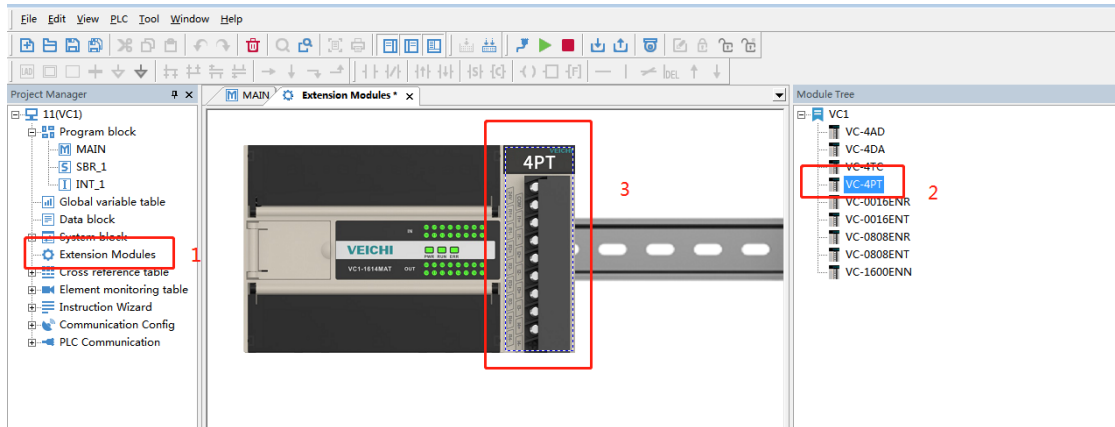

Figure 4-1 Hardware configuration

- 1) 1) Double click on the "4PT" module to enter the 4PT setup screen - as shown below

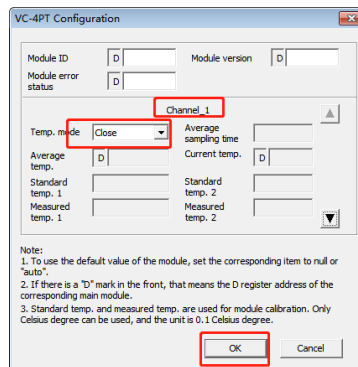

Figure 4-1 First channel setup

- 3) Click on "▼" for the second channel mode configuration.

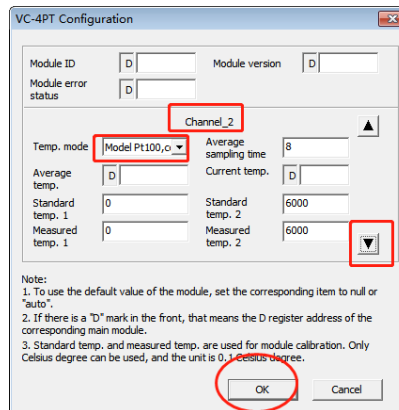

Figure 4-2 Second channel setup

- 4) Click on "▼" to configure the third channel mode and click on "Confirm" when finished;

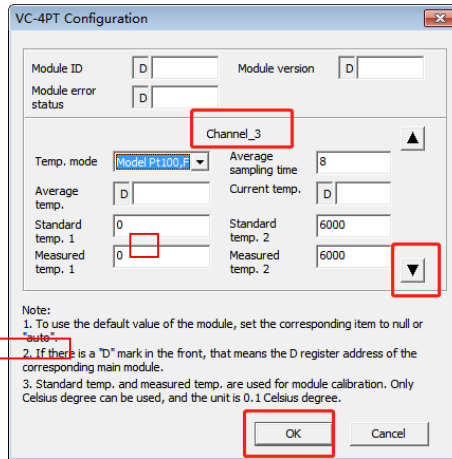

Figure 4-3 Third channel setup

4.2 Characteristic change

If at this point channel 1 outputs 6000 when the actual measured temperature is 600 °C, channel 2 outputs 1200 when the actual measured temperature is 120 °C and channel 3 outputs 2480 when the actual measured temperature is 248 F. Receive the average conversion result with data registers D1, D2 and D3. The changes are shown in Figure 4-4. Note that the characteristic changes are all in degrees Celsius. The range for setting the change value is within ± 1000 (± 100 °C).

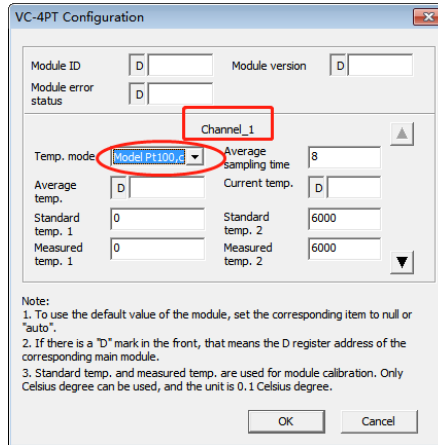

Figure 4-4 Channel characteristics change setting

5 Installation

5.1 Installation size

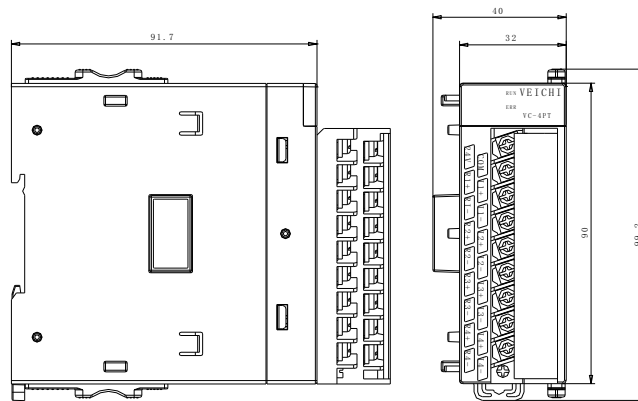

Figure 5-1 Mounting dimensions (in mm)

5.2 Mounting method

An illustration of the installation is shown in Figure 5-2

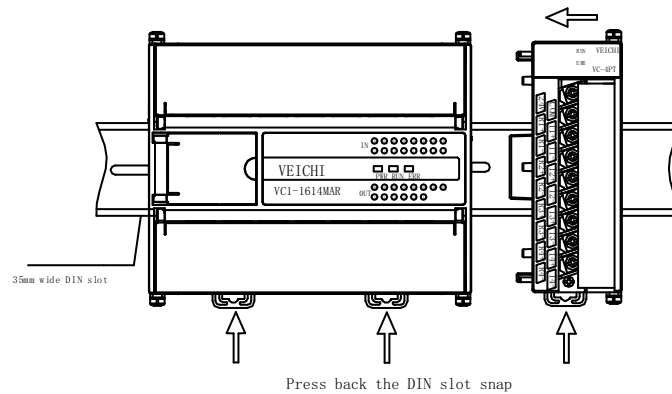

Figure 5-2 Module installation

6 Operational check

6.1 Routine check

1. Check that the analogue input wiring meets the requirements (refer to 1.5 Wiring instructions).
2. Check that the VC-4PT expansion module is reliably plugged into the expansion connector.
3. Check that the 5V power supply is not overloaded. Note: The power supply for the digital part of the VC-4PT comes from the main module and is provided via the expansion interface.
4. Check the application to ensure that the correct operating method and parameter range has been selected for the application.
5. Set the VC1 main module to which the module is connected to a RUN state.

6.2 Fault check

If the VC-4PT does not operate properly, check the following items.

- Check the status of the main module "ERR" indicator.

Blinking: check whether the expansion module is connected and whether the configuration model of the special module is the same as the actual connected module model.

extinguished: the expansion interface is correctly connected.

- Check the analog wiring.

Check that the wiring is accurate, refer to Figure 1-5.

Check the status of the module's "ERR" indicator

If the 24Vdc power supply is normal, then the VC-4PT is faulty.

Off: 24Vdc power supply is normal.

Check the status of the "RUN" indicator

Blinking: The VC-4PT is operating normally.

For Users

1. The scope of the warranty refers to the programmable controller body.
2. The warranty period is eighteen months. If the product fails or is damaged during the warranty period under normal use, we will repair it free of charge.
3. The start of the warranty period is the date of manufacture of the product, the machine code is the only basis for determining the warranty period, equipment without the machine code is treated as out of warranty.
4. Even within the warranty period, a repair fee will be charged for the following cases.
failure of the machine due to non-operation in accordance with the user manual.
Damage to the machine caused by fire, flooding, abnormal voltage, etc..
Damage caused when using the programmable controller for a function other than its normal function.
5. The service charge will be calculated on the basis of the actual cost, and if there is another contract, the contract will take precedence.
6. Please make sure that you keep this card and present it to the service unit at the time of warranty.
7. If you have a problem, you can contact your agent or you can contact us directly.

Suzhou VEICHI Electric Technology Co., Ltd

China Customer Service Center

Address: No. 1000, Songjia Road, Wuzhong Economic and Technological Development Zone

Tel: 0512-66171988 Fax: 0512-6617-3610

Service hotline: 400-600-0303 website: www.veichi.com com

Data version v1.0 filed on July 30, 2021

All rights reserved. The contents are subject to change without notice.

VEICHI Product Warranty Card

Customer information	Company address:	
	Company name:	contacts:
		contact number:
Product information	Product model:	
	Body barcode:	
	Name of agent:	
Fault information	Maintenance time and content:	
	Repairer:	
Mailing address	Suzhou VEICHI Electric Technology Co., Ltd Address: No. 1000, Songjia Road, Wuzhong Economic and Technological Development Zone	