

VEICHI

AC300 Series Frequency Inverter



VEICHI

Shenzhen Veichi Electric Co., Ltd

Third floor, Building Chunsheng, Lulingya Industrial Park, No.1
Tangtou community, Shiyan street, Baoan District, Shenzhen, China
Tel: +86-0755-3686 1688
Fax: +86-755-2968 5680 E-mail: overseas@veichi.com

Facebook: <https://www.facebook.com/veichiglobal/>

Suzhou Veichi Electric Co., Ltd

No.1000 Songjia road, Wuzhong Economic and Technological
Development Zone, Suzhou
Tel: +86-512-6617 1988
Fax: +86-512-6617 3610

Whatsapp: +86- 138 2881 8903

[Http://www.veichi.org](http://www.veichi.org)



Wechat Official Account

*Version 2018 V1.0
Veichi Electric Co., Ltd all rights reserved,
subject to change without notice.



VEICHI Electric Co., Ltd. is a high-tech enterprise that is professionally engaged in the development, manufacturing and marketing of industrial automatic control products, and we are committed to becoming a global leading provider of industrial automatic control products and system solutions.

VEICHI is a competitive company and adopts the dual-base operating mode, which contains the Shenzhen VEICHI and Suzhou VEICHI. Suzhou VEICHI Electric Co., LTD is located in Suzhou Wuzhong Economic and Technological Development Zone, which covers 50 acres. The total construction area is approximately 80 thousand square meters and all properties are privately run. Additionally, VEICHI is always at the forefront of the domestic industrial automation field.

VEICHI has become the flagship company of industrial automation, which owns an innovative R&D team and establishes a good corporation relationship with famous universities and research institutions. Currently, VEICHI owns more than 110 patents of invention, and many of them are in the leading position both at home and abroad, which completely has independent intellectual property rights.

VEICHI produces a variety of core products, including Variable Frequency Drive (VFD), Servo Drive System, Photovoltaic Inverter, PLC, HMI, and Automation Equipment, which are widely used in industries such as oil & gas, chemical, ceramic, crane & construction hoist, lathe, Auto making, metallurgy, electrical cable and wire, plastic, print and package, textile, chemical fiber, metal work and, coalmining and municipal engineering. Suitable solutions and products are always ready to meet the demands and improve comprehensive competitiveness of customers.

"Innovation is the lifeblood of VEICHI", therefore we're committed to becoming one of the leading providers of electric drives, industrial control and green energy products. VEICHI has set up more than 40 brand offices in China and dozens of partners in Asia, Europe and Africa.

VEICHI has been named Chinese Electrical Industry's Top Ten National Brands, Chinese Electrical Industry Top Ten Satisfying Brands and Top Ten National Brands of Inverter Industry. VEICHI products have become the first choice of many enterprises.



AC300 Series High Performance Inverter

Sense & Simplicity

Inherit the superior platform technology
Industrial leading vector control technology
Compatible with AM/PMSM

Simplify

Simple wiring, euro terminal, can save the wiring time and cost
Adopt the domestic general parameters group, optimize the keyboard buttons, easy to use
Simple debugging, specialized host software VCACSoft Ver1.3, can reduce the debugging time and difficulty to the maximum

Thinner, integration of design and aesthetics

The "book-body machine" of inverter
Book narrow-body design, can reduce 60% size at most
Straight deduct of heat dissipation, parallel installation of multi-inverters, can greatly reduce the size of electric cabinet





AC300 Series High Performance Inverter

Ac300 series inverter is the product developed on the platform of VEICHI latest high-performance vector technology. It not only adopts the internationally leading field-orientation vector control technology, which is compatible with AM and PMSM control, but also makes the most reasonable layout of components under the premise of high-performance and high-reliability, so as to achieve the book narrow-body design. Besides, to strengthen the usability and industrial specialization, it is equipped with rich extension interfaces and new extension accessories, realizing the features of high performance, high reliability, high power density and high usability.

Product Features

Features Overview

- High-performance vector general platform, new motor control algorithm.
- Compatible with AM and PMSM, Open loop and Closed-loop.
- Accurate decoupling of torque excitation, excellent performance of dynamic response.
- Full range of book-body design, can save the installation space to the maximum.
- Comprehensive thermal simulation design, can guarantee the rationality of hardware layout.
- New design of air duct and full range of DC fan cooling, safe and reliable.
- Creative grounding method of AC300 series, can quickly solve the EMI problem.
- Modular design of software and hardware, powerful extension capability.
- Rich extension interfaces and extension accessories, can cover all kinds of applications.
- Optimized keyboard design, and support external keyboard.
- Much easier and more convenient debugging on-site, can support the firmware upgrading on-site.
- Tri-proof design of whole machine and tri-proof painting of PCB, can ensure the stability and reliability of products.

General specification

Power range	single-phase 220V 50/60Hz	0.75-220KW
	three-phase 220V 50/60Hz	0.75-220KW
	three-phase 380V 50/60Hz	0.75-710KW
Input	Allowable voltage fluctuation	Voltage:320V~440V Voltage unbalance rate:<3%
	Allowable frequency fluctuation	Frequency:±5%
Output	Distortion rate	IEC61800-2
	Output voltage	0 ~ input voltage, error with 5%
	Output frequency range	0-600Hz
	Overload capacity	150% rated current 1min 180% rated current 10s 200% rated current 0.5s

Performance Features

Support various types of motor / load

AC300 series inverter could drive normal AM, variable frequency motor, AC servo motor, PM, high-speed motor and motorized spindle.



Control modes selection

Control mode	Speed control	Torque control	Position control	Matched motor
VF mode	√	×	×	AM
Voltage frequency separation	√	×	×	Torque motor, EPS power
High-performance VC control without PG	√	√	×	AM, PMSM
High-performance VC control with PG	√	√	√	AM, PMSM

Excellent control performance

Control mode	Speed regulation range	Start-up torque	Matched motor
High-performance VC control without PG	1:100	150%	PMSM
High-performance VC control without PG	1:100	150%	AM
High-performance VC control with PG	1:1000	200%	AM, PMSM

Closed-loop torque response <10ms, steady speed accuracy 0.02%, speed pulsation 0.2%.
Open-loop torque response <20ms, steady speed accuracy 0.2% (PMSM), 0.5% (AM).
The maximum output frequency is 600 Hz under VC control, and the minimum carrier frequency is 1kHz.

High start-up torque characteristic

High torque at lower frequency. It can output 200% rated torque at 0.0Hz under closed-loop VC mode, and can run smoothly with load at ultra-low speed 0.01Hz. Powerful lower torque output, can effectively ensure a stable and smooth start.

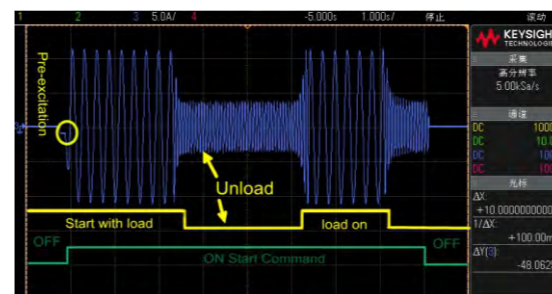

Stable torque output under torque control mode. The torque linearity bias is within 3%, which greatly guarantees the stable operation of devices.

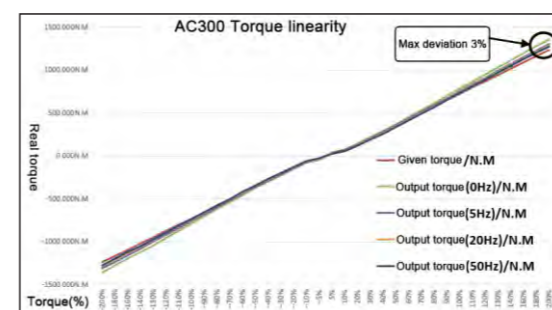

Over-excitation braking function

Without using braking resistance, it can realize fast braking with over-excitation braking function in some occasions of inertia stop, so as to improve the usability of products. The over-excitation function could effectively suppress the rising of bus voltage in the process of deceleration to avoid the overvoltage fault, and at the same time, it could realize fast braking to meet the fast stop while power off.

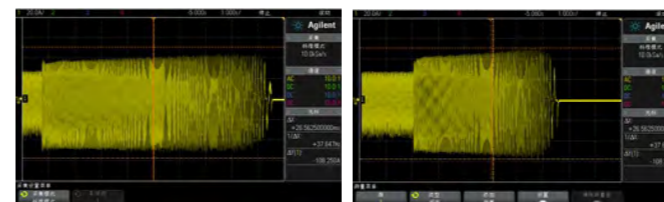

Disable over excitation

Enable over excitation

Stable high-speed weak-magnetic control

The new weak-magnetic control algorithm and high-bandwidth current VC control algorithm realize the steady high-speed weak-magnetic operation, and could support maximum 12 times of weak-magnetic high-precision output

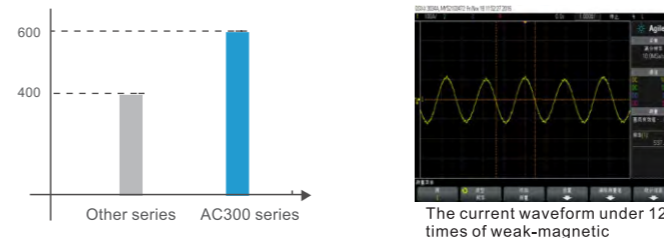

■ Other series: The maximum output frequency could reach 320/100Hz under VC control;
■ AC300 series: The maximum output frequency could reach 600Hz under VC control;

Self-tuning of motor parameters

It could accurately acquire the motor parameters both in rotary and static self-tuning, so as to provide higher control accuracy and response speed, which is convenient and simple.

Rotary self-tuning: Must unload the motor. Suit for applications with higher requirement of control accuracy.

Fully static self-tuning: Leading motor tuning algorithm, can acquire the motor parameters in static status, which is comparable to the rotary self-tuning.

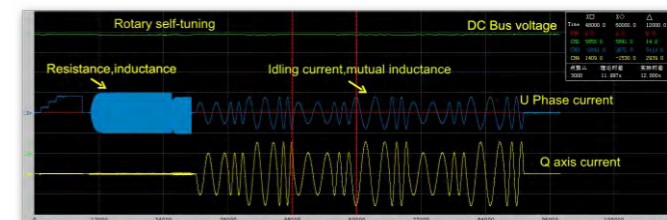

Rotary self-tuning

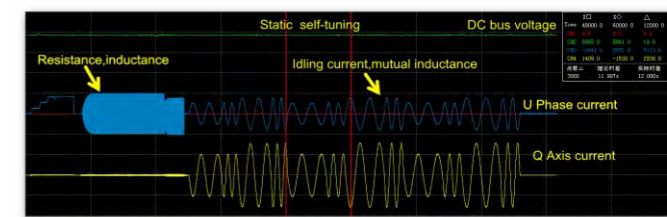

Fully static self-tuning

Software suppression function

Over current suppression

The current suppression function could avoid the frequent OC fault of inverter. While the current is over the current protection point, it could continuously limit the current below the protection point, so as to protect devices, prevent the overcurrent fault caused by sudden load or interference and reduce the loss caused by stop without reason.

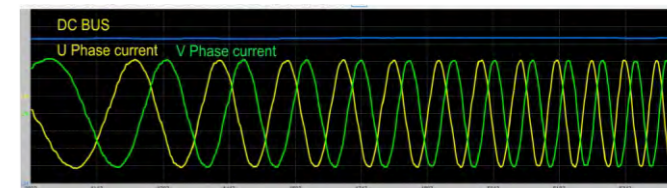

Over voltage suppression

The overvoltage suppression function could prevent inverter from overvoltage fault in ACC/DEC process. During ACC/DEC, if the bus voltage of inverter reaches or exceeds the overvoltage protection point, the overvoltage suppression function could suppress the rising of bus voltage by automatically adjust the operation frequency, so as to protect the devices and avoid the overvoltage fault caused by the rising of bus voltage.

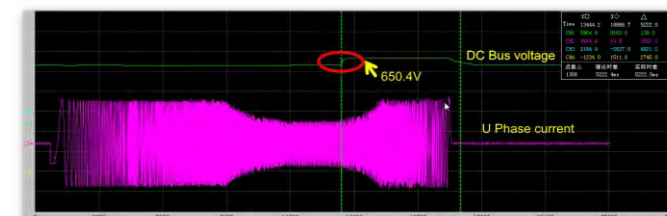

Random carrier frequency

Compared with the sharp motor noise of fixed carrier frequency, the output voltage harmonic spectrum of random carrier frequency is uniform in a wider frequency range, which makes the motor noise much softer.



Turn off the spectrum analysis of random carrier frequency

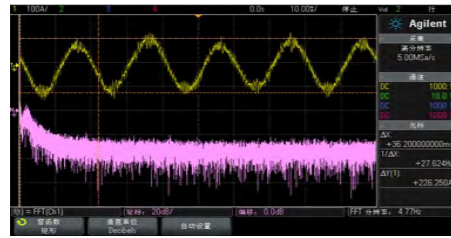

Turn on the spectrum analysis of random carrier frequency

Excellent energy-saving functions

Adopt the new generation of energy-saving control technology to realize the high-efficiency operation of induction motor; reduce the excitation current according to the load current, and automatically adjust according to the loading condition; improve the motor efficiency at most; reduce the motor consumption and energy consumption. 30% of AM&PMSM adopt the VC mode to drive PMSM and the energy utilization could increased by more than 10%.

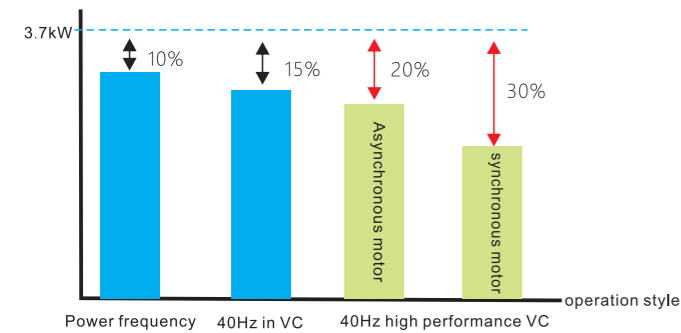

Comparison diagram of fan energy saving

Support software upgrade on-line

AC300 can upgrade software on-line through VEICHI firmware upgrade software.

AC300 built-in software can be upgraded and replaced directly through the traditional RS485 serial port.

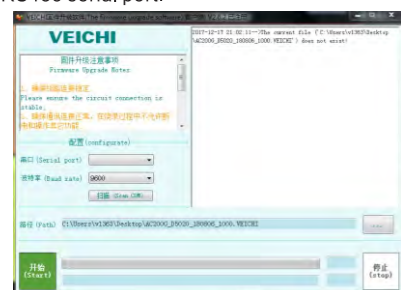

Powerful upper machine software

There is user-friendly upper machine software for AC300, which is convenient to operate and configure. Besides the keyboard, users can also use VCACSoft Ver1.3 to set, copy and monitor parameters. It could timely and conveniently provide the VFD state information for users, so as to provide unprecedented flexibility for debugging, setting, monitoring and troubleshooting.

The software could operate in Windows environment, and perform data exchange by common RS485 interface or field bus.

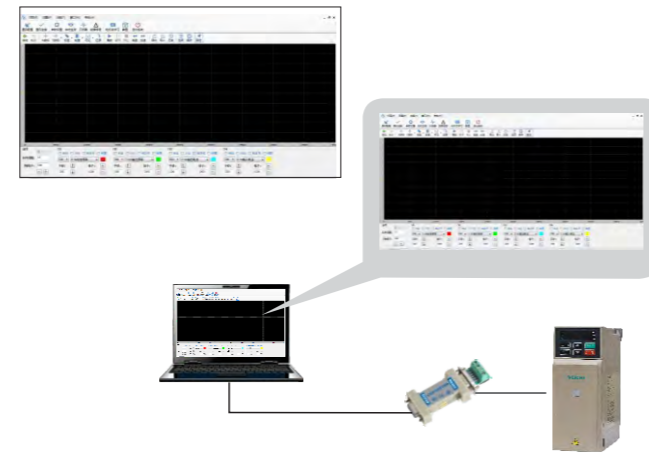
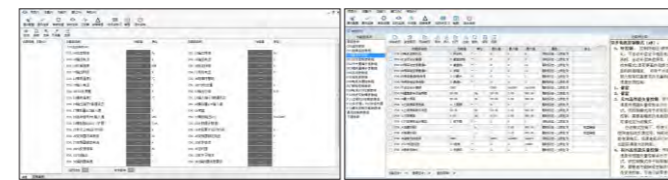

Structural hardware features

Simple internal layout, convenient wiring operation

Full range of narrow-body design and strict control in structure dimension. The main models contain most regular applications, various extension interfaces and ordered terminal layout, which is convenient for wiring.

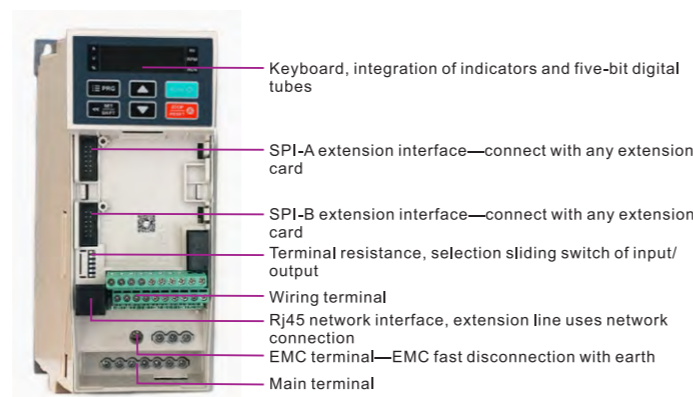

Standard configuration of terminals

No.	Unit Circuit	Quantity	Remarks
1	Common X input	5 channel	Dual-direction input
2	Common Y output	1 channel	
3	Relay output	1 channel	Normal on/off
4	10V power output	1 channel	50mA
	24V power output	1 channel	200mA
5	Voltage/Current analog input	2 channel	V/A support random switch
6	Analog output (optional)	1 channel	0-10V output
			0-20mA output
			0-50KHz pulse output
7	Rs485 communication	1 channel	ModBus-RTU
8	Low-speed pulse input	1 channel	X5:0-5 KHz input

New book-body structure

Ac300 series all adopt book narrow-body design, and the volume is 60% smaller than the original, which is the real "book-body machine" of inverter.

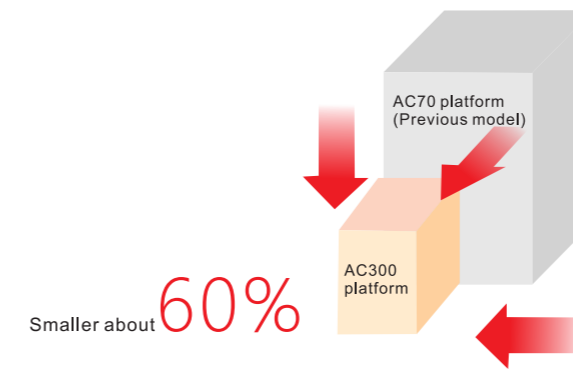

New structure design

Adopt separate deduct design of components and radiator: strengthened protection of capacitors, MOS tube and relays, closed design of inverter sides, to improve the ability to resist environment.



Wide tooth surface of heat dissipation, high air speed design, can ensure no reduction of capacitors with full power inverter in high temperature.

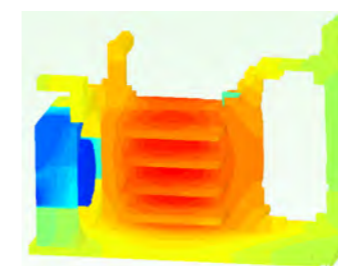

Optimized structure design

Book narrow-body design, rationally utilization of space, can greatly save the size and cost of main cabinet.

380V 2.2kW demonstration

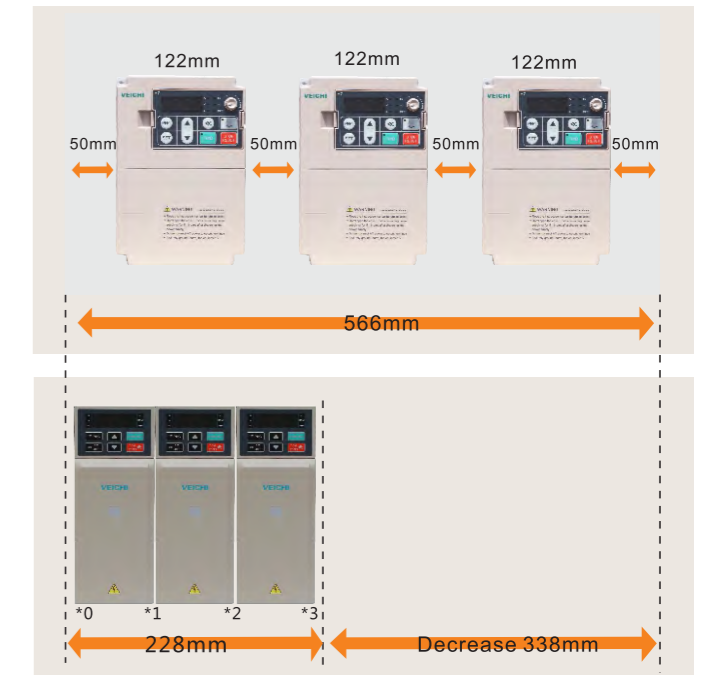

Configuration of braking unit and reactor

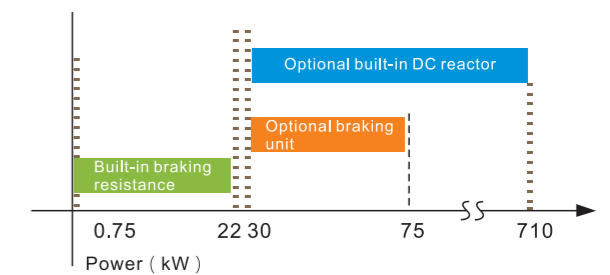

- 0.75~22kW built-in braking unit
- 30~75kW optional built-in braking unit
- 30~710kW optional built-in reactor (630~710kW standard configured with input reactor)

Siding selection of interface features

Convenient siding selection of interface features, can fast select input/output features with common screwdrivers.

Sliding diagram	Item	Selection position	Function description
RS485 OFF	485 terminal resistance	ON	RS485 communication connects to 120 ohm terminal resistance
AO-F OFF	AO output - power	ON	AO2 interface: 0.0~100kHz frequency output
AO-I OFF	AO output - current	ON	AO2 interface: 0~20mA or 4~20mA current output
AO-U OFF	AO output - voltage	ON	0~10V voltage output
AI1 U	AI1 input - current/voltage	I	AI1 interface input 0~20mA or 4~20mA current or 0~10V voltage
AI2 U	AI2 input - current/voltage	I	AI2 interface input 0~20mA or 4~20mA current or 0~10V voltage

Keyboard operation

A new designed keyboard with operational superiority. Built-in keyboard and external keyboard support double display(control right can be selected by parameter)

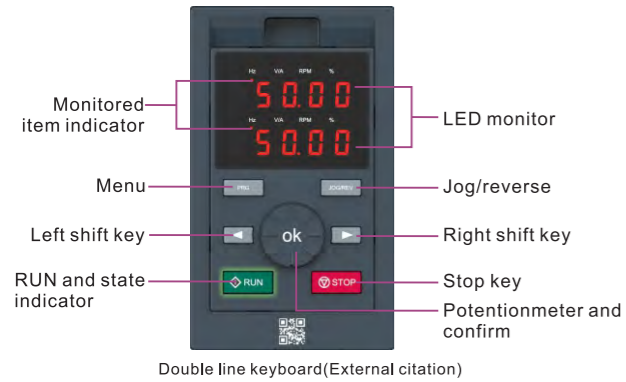

Note: the following 37KW adopts integrated keyboard, 37KW steel machine adopts double line keyboard.

Name	State	Meaning
Unit indicator light	Hz	Spark/On
	A	On
	V	Spark/On
	RPM	On
	%	Spark/On
State indicator light	RUN	On
	RUN	Spark
	RUN	Off

Fan fast disassembly design

With the innovative fan structure design, the fan can be quickly replaced and cleaned without the aid of external tools on the premise of ensuring the stability and efficiency of the fan.

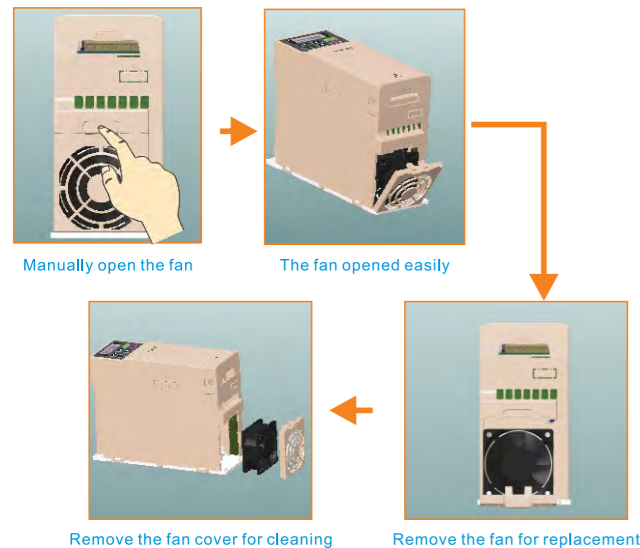

MB Series

Selection of European terminal conforming to IEC60988-2-1:UL1059:UL 486E specification. Save the connection time while ensuring the safety and reliability: wire stripping---Line number---fasten. AC300 inverter adopt MB series on small power main circuit. Using the European terminal to connect the main circuit in the cabinet to the main loop at least half the time compared to the previous machine. Greatly improve the efficiency of customer assembly.



Wire Stripping→line Number→press Wire→fasten

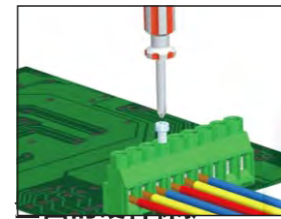

Wire Stripping→line Number→fasten

	AC300 Model	Wire diameter ϕ (mm)	Intercepting area of wire (mm ²)	Wire strip length (mm)
Main circuit terminal	0.75kW-2.2kW	0.25-2.5	0.05-5.2	7-8
	4.0KW-5KW	0.5-2.5	0.2-5.2	6-7
	7.5KW-11KW	0.8-4	0.5-13	10-11
Schematic diagram of stripping				

Wide voltage design

Input voltage range is 320V-460V. Avoid the impact of voltage fluctuations and meet the harsh grid environment.

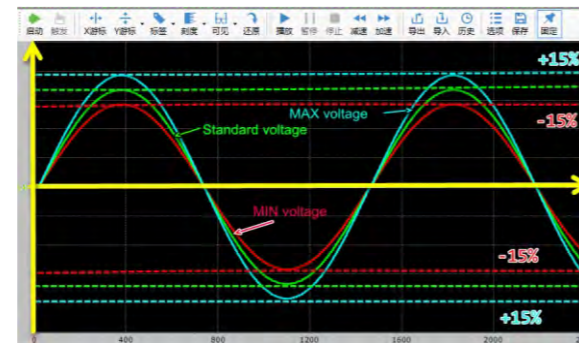

EMC disconten ground line design

Using innovative EMC disconnect ground line design, fast selection through terminal.



Comprehensive hardware protection

It has such functions as output to ground protection, internal buffer relay protection, fan drive circuit protection, external 24V DC short circuit protection, motor overload protection and other hardware protection functions, so as to realize the omni directional protection from the inverter's internal and peripheral devices.

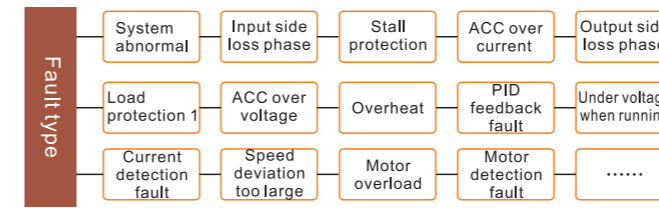

A new electric motor to ground short circuit detection

The inverter starts to detect the ground short circuit immediately. Once the motor side is found short circuit, then inverter stop the output and protect the motor.

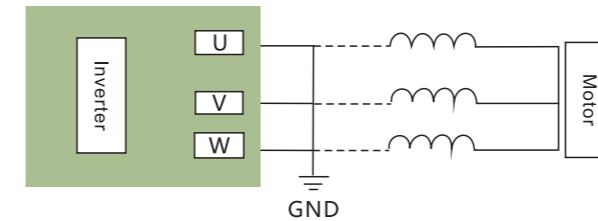

Expansion

Super expansion

Avariety of expansion interfaces to meet various conventional applications. AC300 control board retains two SPI high speed channel outward extension card, Control board automatic identification extension card including expansion card setting parameter group at the same time.

Expansion card

Mode	Requirement
IO expansion card	Optional, high speed pulse, relay
Speed tracking card	Optional (Default software tracking)
PG card	Optional, Multi type encoder
Easy logic board expansion card	Optional
.....	In development

Communication extension card



Communication type extension card model	Requirements
PROFIBUS-DP card	Optional
CANopen card	Optional
PROFINET card	Optional
Ethernet/EtherCAN card	Optional
.....	

IO extension card

property	Terminal	Specification
Input IO	Expansion X6/X7/X8/X9/X10	PLC/COM, Common cathode, Common anode
High speed pulse input	X10	0-100KHz
Digital output	Expansion Y2	DC24V/50mA
Relay output	Expansion relay TA2/TB2/TAC2	3A/240VAC
Temperature detection of synchronous motor	PK+/PK-	Support PT100/PT1000/KTY84, motor temperature detection
Common port	COM/PLC2	External terminal
Common ground	GND	
Change-over Switch	S7	Polarity selection of Input terminal

Logic extension card

Inverter takes the place of PLC to perform simple logic control. Adopt development environment with a wide application of MELSEC programmable controllers. The product integrates universal and comprehensive functional blocks.



IOT of VEICHI

Intelligent terminal. High positioning accuracy. Small and beautiful. Easy to install. Using GPRS and GSM dual mode communication mode, stable running, reliable performance. Realized online monitoring and faults diagnosis though remote detection module. Provide customers with a larger range of value-added services.

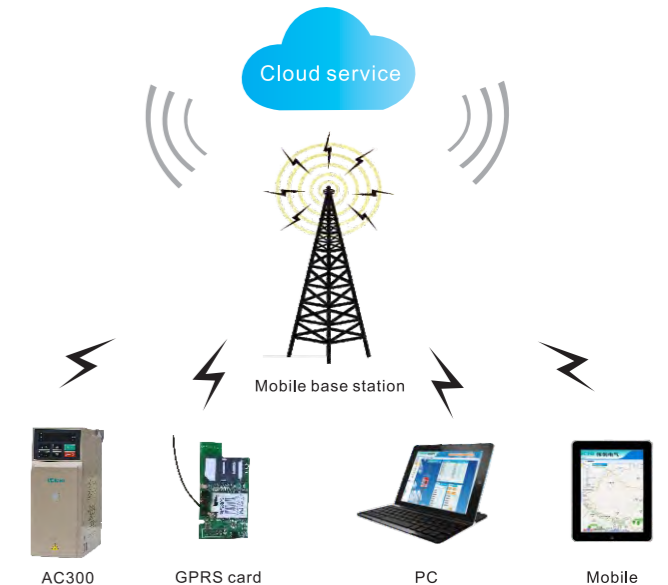

Model specification

AC300-T3-037 G/45 P-B (L)

- Accessories type
 - B : Built-in brake unit
 - L : Built-in DC reactor
 - BL : Built-in brake unit and dc reactor
- VFD type
 - G : General
 - GD : Cabinet with base
- Power class :
 - 2R2: 2.2KW 004: 4KW
- Voltage class
 - T: Three phase S: Single phase D: DC input
 - 2: 220V , 3: 380V , 4: 440V ,
 - 6: 660V , 11:1140V
- Series name
 - AC300

Installation dimension

Plastic model

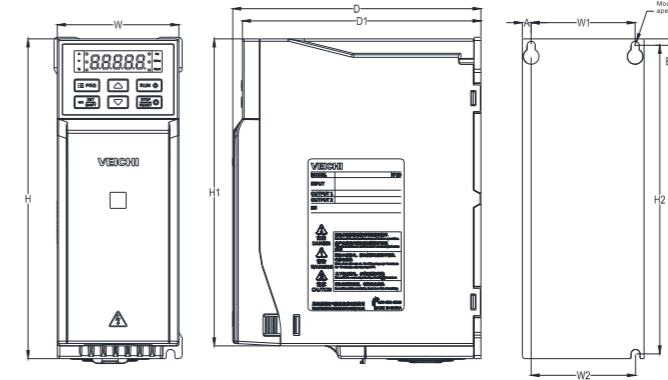

Model	Overall dimension(mm)					Installation dimension (mm)					Installation aperture
	W	H	H1	D	D1	W1	W2	H2	A	B	
AC300-T/S2-R75G-B	76	200	192	155	149	65	65	193	5.5	4	3-M4
AC300-T/S2-1R5G-B											
AC300-T/S2-2R2G-B	100	242	231	155	149	84	86.5	231.5	8	5.5	3-M4
AC300-T/S2-004G-B											
AC300-T/S2-5R5G-B	116	320	307.5	175	169	98	100	307.5	9	6	3-M5
AC300-T3-R75G/1R5P-B	76	200	192	155	149	65	65	193	5.5	4	3-M4
AC300-T3-1R5G/2R2P-B											
AC300-T3-2R2G-B	100	242	231	155	149	84	86.5	231.5	8	5.5	3-M4
AC300-T3-004G/5R5P-B											
AC300-T3-5R5G/7R5P-B	116	320	307.5	175	169	98	100	307.5	9	6	3-M5

VFD rated output current

Voltage	220V	380V	Voltage	220V	380V
Power	Rated output current (A)		Power	Rated output current (A)	
0.75	4	3	110	380	210
1.5	7	4	132	420	250
2.2	10	6	160	550	310
4	16	10	185	600	340
5.5	20	13	200	660	380
7.5	30	17	220	720	415
11	42	25	250		470
15	55	32	280		510
18.5	70	38	315		600
22	80	45	355		670
30	110	60	400		750
37	130	75	450		810
45	160	90	500		860
55	200	110	560		990
75	260	150	630		1100
90	320	180	710		1260

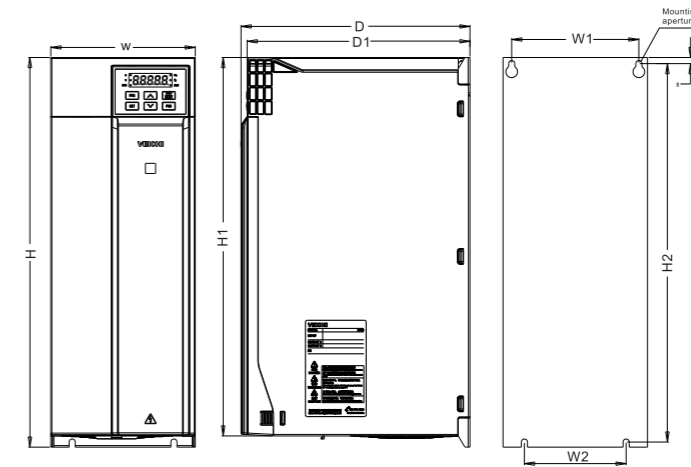

Model	Overall dimension(mm)					Installation dimension (mm)					Installation aperture
	W	H	H1	D	D1	W1	W2	H2	B		
AC300-T/S2-7R5G-B	142	383	372	225	219	125	100	372	6	4-M5	
AC300-T/S2-011G-B											
AC300-T/S2-015G	172	430	/	225	219	150	150	416.5	7.5	4-M5	
AC300-T2-018G											
AC300-T2-022G	142	383	372	225	219	125	100	372	6	4-M5	
AC300-T3-015G/018P-B											
AC300-T3-018G/022P-B	172	430	/	225	219	150	150	416.5	7.5	4-M5	
AC300-T3-022G/030P-B											
AC300-T3-030G/037P	172	430	/	225	219	150	150	416.5	7.5	4-M5	
AC300-T3-037G/045P											

Steel model

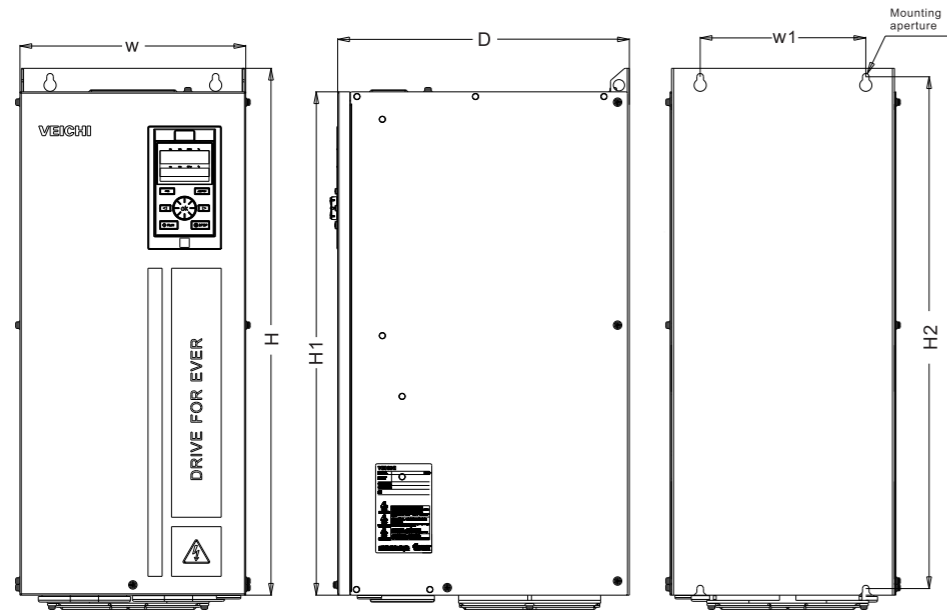

Model	Overall dimension(mm)				Installation dimension (mm)		Installation aperture
	W	H	H1	D	W1	H2	
AC300-T2-030G	240	560	535	310	176	544	4-M6
AC300-T2-037G							
AC300-T2-045G							
AC300-T2-055G	270	638	580	350	195	615	4-M8
AC300-T3-045G/055P	240	560	535	310	176	544	4-M6
AC300-T3-055G/075P							
AC300-T3-075G/090P							
AC300-T3-090G/110P	270	638	580	350	195	615	4-M8
AC300-T3-110G/132P	350	738	680	405	220	715	4-M8
AC300-T3-132G/160P-L							
AC300-T3-160G/185P-L							
AC300-T3-185G/200P-L	360	940	850	480	200	910	4-M16
AC300-T3-200G/220P-L							
AC300-T3-220G/250P-L							
AC300-T3-250G/280P-L	370	1140	1050	545	200	1110	4-M16
AC300-T3-280G/315P-L							
AC300-T3-315G/355P-L							
AC300-T3-355G/400P-L	400	1250	1140	545	240	1213	4-M16
AC300-T3-400G/450P-L							
AC300-T3-450G/500P-L							
AC300-T3-500G/560P-L	460	1400	1293	545	300	1363	4-M16
AC300-T3-560G/600P-L							

Cabinet Model

Model	Overall dimension(mm)				Installation dimension (mm)		Installation aperture
	W	H	H1	D	W1	H2	
AC300-T3-630G/710P	800	1900	1800	700	564	626	φ14
AC300-T3-710G/800P							

Wiring Diagram

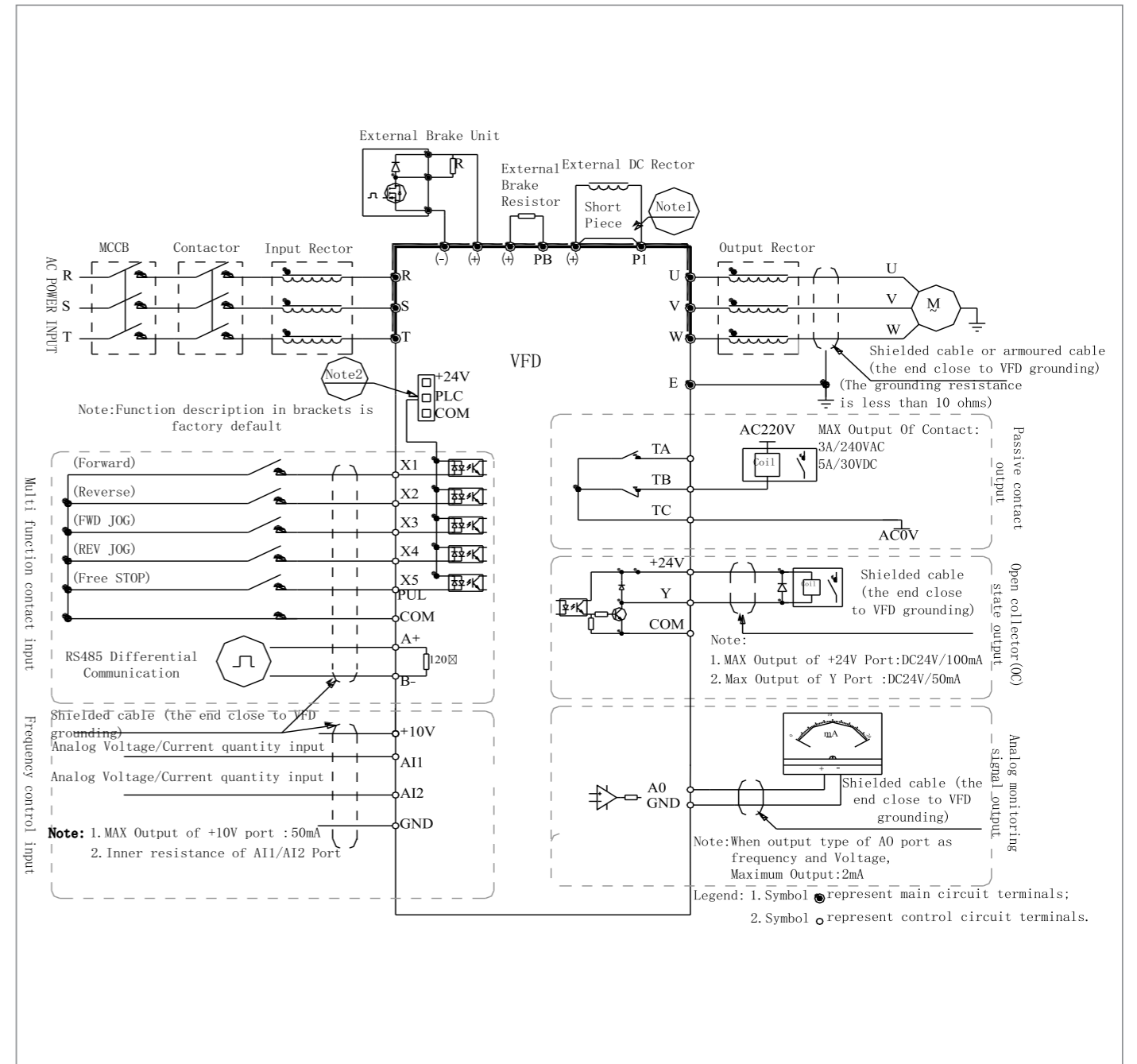

Note:

- When installing DC reactor, make sure to dismantle the short connector between terminal P1 and (+).
- NPN or PNP transistor signal can be selected as the input of multi-function input terminals (X1~X5/PUL). The inverter built-in power supply (+24V terminal) or external power supply (PLC terminal) can be selected as bias voltage. Factory default: "+24V" short connects with "PLC", which locates between RJ45 and terminals.
- Analog monitor output is the special output for meters such as frequency meter, current meter and voltage meter. It can't be used for control operations such as feedback control.
- As there are multi pulse types, please refer to the details of wiring connection modes.

Optional parts

AC300-PG01

5V differential signal input, Maximum frequency 500KHz, With input signal disconnection detection function.

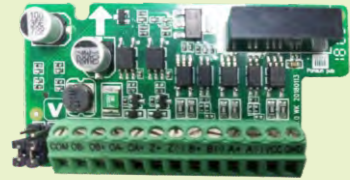

AC300DP01

Profibus Communication Expansion Card



AC300RT1

Resolver card, It can support four different transformation ratios: 0.219, 0.286, 0.5, 0.58. Factory default: 0.5.

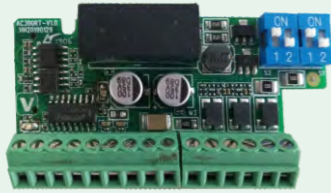

KBD10-15

External LED 5 Bit display and operation keypad, with Potentiometer speed regulation.



AC300IO1

Four digital input (X10 can support 50KHz pulse input), one digital output, one analog input, one relay output. It can also support temperature detection (PT100 & KTY84).



KBD300-25

Double line external 5 bit display, Silicone buttons, Digital potentiometer.



AC300CAN1

CANopen extension card

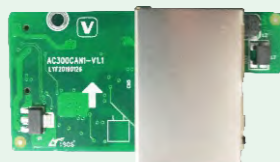

AC300-GPRS

Device Positioning and Maintenance. Real-time Monitoring. Data Acquisition.



Application case

